

# TOSHIBA

Hi-Fi **VHS**

Video Cassette Recorder

## W-706

---

OWNER'S MANUAL



SQP8

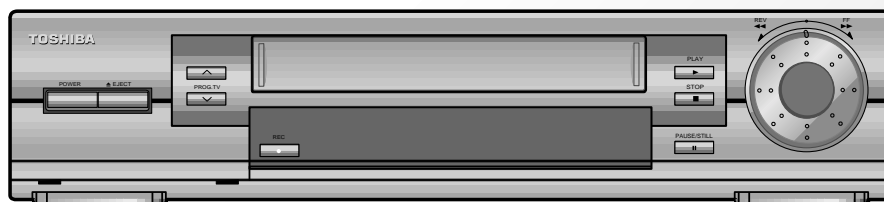

 This publication is printed  
on recycled paper

70971837

# SAFETY PRECAUTIONS

---

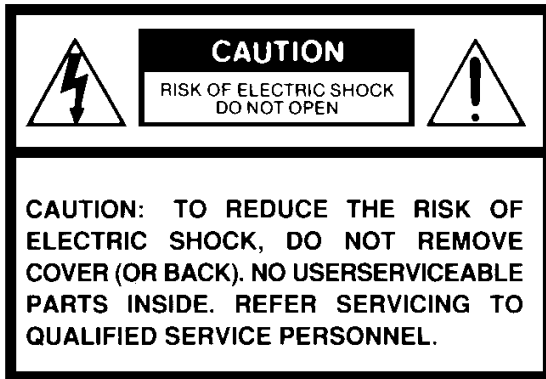

The lightning flash with arrowhead symbol, within an equilateral triangle, is intended to alert the user to the presence of uninsulated “dangerous voltage” within the product’s enclosure that may be of sufficient magnitude to constitute a risk of electric shock to persons.



The exclamation point within an equilateral triangle is intended to alert the user to the presence of important operating and maintenance (servicing) instructions in the literature accompanying the appliance.

**WARNING: TO REDUCE THE RISK OF FIRE OR ELECTRIC SHOCK, DO NOT EXPOSE THIS APPLIANCE TO RAIN OR MOISTURE. DANGEROUS HIGH VOLTAGES ARE PRESENT INSIDE THE ENCLOSURE. DO NOT OPEN THE CABINET. REFER SERVICING TO QUALIFIED PERSONNEL ONLY.**

**CAUTION: TO PREVENT ELECTRIC SHOCK, MATCH WIDE BLADE OF PLUG TO WIDE SLOT, FULLY INSERT.**

Product Name: Video Cassette Recorder  
Model Number: W-706

FCC Notice: “Declaration of Conformity”

This device complies with part 15 of the FCC Rules. Operation is subject to the following two conditions: (1) This device may not cause harmful interference, and (2) this device must accept any interference received, including interference that may cause undesired operation.

Contact: Toshiba America Consumer Products, Inc.  
Address: 1420 Toshiba Drive, Lebanon, TN37087  
Telephone: 615-449-2360

User Installer Caution: Changes or modification made to this equipment not expressly approved by Toshiba Corporation or parties authorized by Toshiba Corporation could void the user’s authority to operate the equipment.

**Note to CATV system installer:**

This reminder is provided to call the CATV system installer’s attention to Article 820-40 of the NEC that provides guidelines for proper grounding and, in particular, specifies that the cable ground shall be connected to the grounding system of the building, as close to the point of cable entry as practical.

# IMPORTANT PRECAUTIONS

## Save Original Packing Materials

The original shipping carton and packing materials will come in handy if you ever have to ship your VCR. For maximum protection, repack the set as it was originally packed at the factory.

## Avoid Volatile Liquid

Do not use volatile liquids, such as an insect spray, near the unit.  
Do not leave rubber or plastic products touching the unit for a long time. They will mar the finish.

## Moisture Condensation

Never operate this unit immediately after moving it from a cold location to a warm location. When the VCR is exposed to such a change in temperature, moisture may condense on the cylinder inside, one of its most crucial internal parts. To prevent the VCR from possible damage, do not use the unit for at least 2 hours when there is an extreme or sudden change in temperature.

## Compatibility

This video cassette recorder (VCR) is compatible with any other VCR bearing the **VHS** mark. HQ VHS equipment is also compatible with existing, non-HQ VHS equipment.

## Copyright

It is permissible to record television programs, film, video tapes and other material only in the event that third party copyrights and other rights are not violated.



As an ENERGY STAR® Partner, TOSHIBA has determined that this product or product model meets the ENERGY STAR® guidelines for energy efficiency.

In the spaces provided below, record the Model and Serial No. located at the rear of your video cassette recorder.

Model No. \_\_\_\_\_ Serial No. \_\_\_\_\_

Retain this information for future reference.

# IMPORTANT SAFETY INSTRUCTIONS

**CAUTION: PLEASE READ AND OBSERVE ALL WARNINGS AND INSTRUCTIONS GIVEN IN THIS OWNER'S MANUAL AND THOSE MARKED ON THE UNIT. RETAIN THIS BOOKLET FOR FUTURE REFERENCE.**

This set has been designed and manufactured to assure personal safety. Improper use can result in electric shock or fire hazard. The safeguards incorporated in this unit will protect you if you observe the following procedures for installation, use and servicing. This unit is fully transistorized and does not contain any parts that can be repaired by the user.

**DO NOT REMOVE THE CABINET COVER, OR YOU MAY BE EXPOSED TO DANGEROUS VOLTAGE. REFER SERVICING TO QUALIFIED SERVICE PERSONNEL ONLY.**

**1. Read owner's manual**

After unpacking this product, read the owner's manual carefully, and follow all the operating and other instructions.

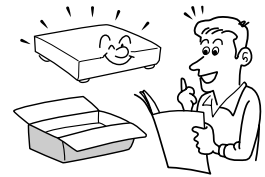

**2. Power Sources**

This product should be operated only from the type of power source indicated on the marking label. If you are not sure of the type of power supply to your home, consult your product dealer or local power company. For products intended to operate from battery power, or other sources, refer to the operating instructions.



**3. Grounding or Polarization**

This product may be equipped with a polarized alternating current line plug (a plug having one blade wider than the other). This plug will fit into the power outlet only one way. This is a safety feature. If you are unable to insert the plug fully into the outlet, try reversing the plug. If the plug should still fail to fit, contact your electrician to replace your obsolete outlet. Do not defeat the safety purpose of the polarized plug.

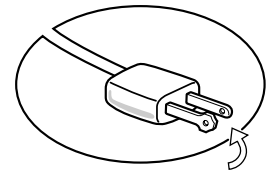

**4. Ventilation**

Slots and openings in the cabinet are provided for ventilation and to ensure reliable operation of the product and to protect it from overheating, and these openings must not be blocked or covered. The openings should never be blocked by placing the product on a bed, sofa, rug or other similar surface. This product should not be placed in a built-in installation such as a bookcase or rack unless proper ventilation is provided or the manufacturer's instructions have been adhered to.



**5. Heat**

The product should be situated away from heat sources such as radiators, heat registers, stoves, or other products (including amplifiers) that produce heat.

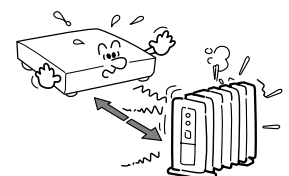

**6. Water and Moisture**

Do not use this product near water - for example, near a bath tub, wash bowl, kitchen sink, or laundry tub; in a wet basement; or near a swimming pool and the like.

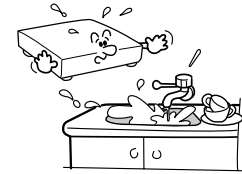

**7. Cleaning**

Unplug this product from the wall outlet before cleaning. Do not use liquid cleaners or aerosol cleaners. Use a damp cloth for cleaning.



**8. Power-Cord Protection**

Power-supply cords should be routed so that they are not likely to be walked on or pinched by items placed upon or against them, paying particular attention to cords at plugs, convenience receptacles, and the point where they exit from the product.



**9. Overloading**

Do not overload wall outlets; extension cords, or integral convenience receptacles as this can result in a risk of fire or electric shock.

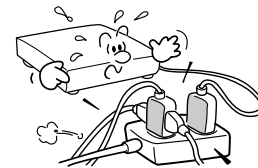

**10. Outdoor Antenna Grounding**

If an outside antenna or cable system is connected to the product, be sure the antenna or cable system is grounded so as to provide some protection against voltage surges and built-up static charges. Article 810 of the National Electrical Code, ANSI/NFPA 70, provides information with regard to proper grounding of the mast and supporting structure, grounding of the lead-in wire to an antenna discharge unit, size of grounding conductors, location of antenna-discharge unit, connection to grounding electrodes, and requirements for the grounding electrode.

**EXAMPLE OF ANTENNA GROUNDING AS PER NATIONAL ELECTRICAL CODE**

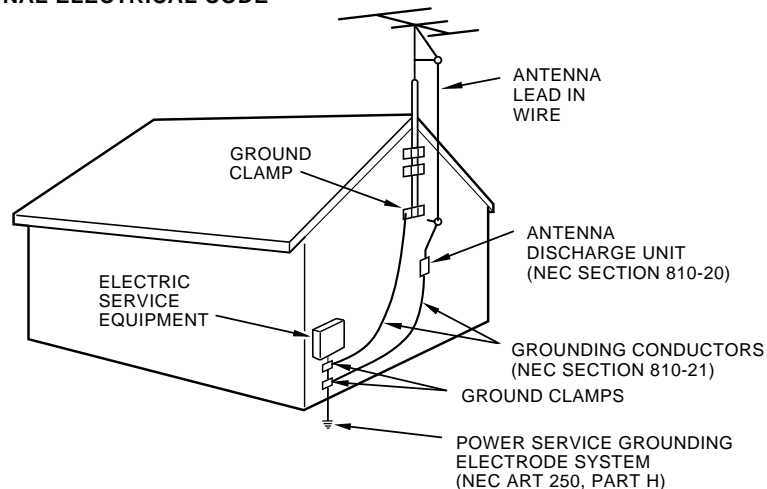

NEC – NATIONAL ELECTRICAL CODE

S2898A

**11. Power Lines**

An outside antenna system should not be located in the vicinity of overhead power lines or other electric light or power circuits, or where it can fall into such power lines or circuits. When installing an outside antenna system, extreme care should be taken to keep from touching such power lines or circuits as contact with them might be fatal.

# IMPORTANT SAFETY INSTRUCTIONS

## 12. Lightning

For added protection for this product during storm, or when it is left unattended and unused for long periods of time, unplug it from the wall outlet and disconnect the antenna or cable system. This will prevent damage to the product due to lightning and power-line surges.

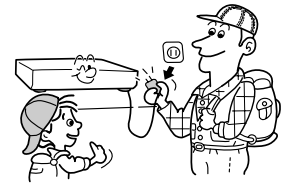

## 13. Object and Liquid Entry

Never push objects of any kind into this product through openings as they may touch dangerous voltage points or short-out parts that could result in a fire or electric shock. Never spill liquid of any kind on the product.



## 14. Attachments

Do not use attachments not recommended by the product manufacturer as they may cause hazards.

## 15. Accessories

Do not place this product on an unstable cart, stand, tripod, bracket, or table. The product may fall, causing serious injury to a child or adult, and serious damage to the product. Use only with a cart, stand, tripod, bracket, or table recommended by the manufacturer, or sold with the product. Any mounting of the product should follow the manufacturer's instructions, and should use a mounting accessory recommended by the manufacturer.

A product and cart combination should be moved with care. Quick stops, excessive force, and uneven surfaces may cause the product and cart combination to overturn.



## 16. Damage Requiring Service

Unplug this product from the wall outlet and refer servicing to qualified service personnel under the following conditions:

- a) When the power-supply cord or plug is damaged.
- b) If liquid has been spilled, or objects have fallen into the product.
- c) If the product has been exposed to rain or water.
- d) If the product does not operate normally by following the operating instructions. Adjust only those controls that are covered by the operating instructions as an improper adjustment of other controls may result in damage and will often require extensive work by a qualified technician to restore the product to its normal operation.
- e) If the product has been dropped or damaged in any way.
- f) When the product exhibits a distinct change in performance - this indicates a need for service.

## 17. Servicing

Do not attempt to service this product yourself as opening or removing covers may expose you to dangerous voltage or other hazards. Refer all servicing to qualified service personnel.



## 18. Replacement Parts

When replacement parts are required, be sure the service technician has used replacement parts specified by the manufacturer or have the same characteristics as the original part. Unauthorized substitutions may result in fire, electric shock, or other hazards.

## 19. Safety Check

Upon completion of any service or repairs to this product, ask the service technician to perform safety checks to determine that the product is in proper operating condition.

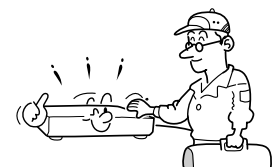

# Contents

## INTRODUCTION

---

Provides important notes and general explanation of the VCR, including names of the buttons, jacks, etc.

<b>SAFETY PRECAUTIONS</b> .....	<b>2</b>
<b>IMPORTANT PRECAUTIONS</b> .....	<b>3</b>
<b>IMPORTANT SAFETY INSTRUCTIONS</b> .....	<b>4</b>
<b>Contents</b> .....	<b>7</b>
<b>Identification of Controls</b> .....	<b>8</b>
• Front Panel	
• Remote Control	
• VCR Display	
• Rear Panel	

## PREPARATION

---

Explains what you need to do before operating the VCR.

<b>How to Use the Remote Control</b> .....	<b>10</b>
<b>Connections</b> .....	<b>11</b>
<b>Auto Set Up</b> .....	<b>14</b>
<b>Initial Settings Using On-screen Display</b> .....	<b>15</b>
• Setting the Language	
• Optional settings on the SET UP screen	
• Setting the Clock	
<b>Storing Channels on the VCR</b> .....	<b>17</b>
<b>Video Cassette Use</b> .....	<b>19</b>

## PLAYBACK

---

Explains variable functions concerning playback.

<b>Playback</b> .....	<b>20</b>
• 19 $\mu$ HEAD	

## Variable Speed Playback .....

- Picture Search
- Still Picture
- Slow-motion Picture
- Frame Advance
- Double Speed Playback
- Shuttle Dial Operation

## Useful Functions in Tape Operation .....

- Counter Function
- Tape Remaining Time
- Index Search Function

## RECORDING

---

Explains recording functions.

<b>Recording a TV Program</b> .....	<b>25</b>
• Watching a TV program while recording another	
• Recording off time setting	
<b>Timer Program Recording</b> .....	<b>26</b>
<b>VCR Plus+ C<sup>3</sup>® system Set-up</b> .....	<b>29</b>
<b>VCR Plus+ C<sup>3</sup>® system Recording</b> ..	<b>31</b>
<b>Cable Box Set-up</b> .....	<b>33</b>
<b>DSS® Satellite Receiver Set-up</b> .....	<b>37</b>
<b>MTS Broadcast Compatibility</b> .....	<b>41</b>
<b>Simulcast Recording</b> .....	<b>42</b>

## ADDITIONAL INFORMATION

---

<b>Multi Brand Remote Control</b> .....	<b>43</b>
<b>Before Calling Service Personnel</b> ...	<b>45</b>
<b>Specifications</b> .....	<b>47</b>
<b>Accessories</b> .....	<b>47</b>
<b>LIMITED WARRANTY</b> .....	<b>48</b>

# Identification of Controls

See the page in  for details.  
This manual shows the names of buttons in italics.

## Front Panel

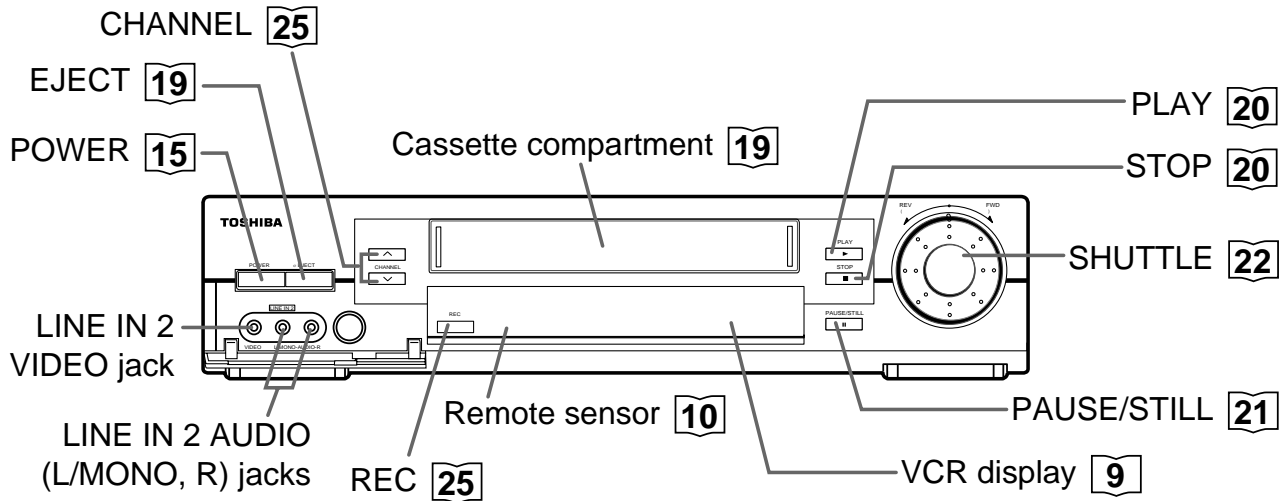

## Remote Control

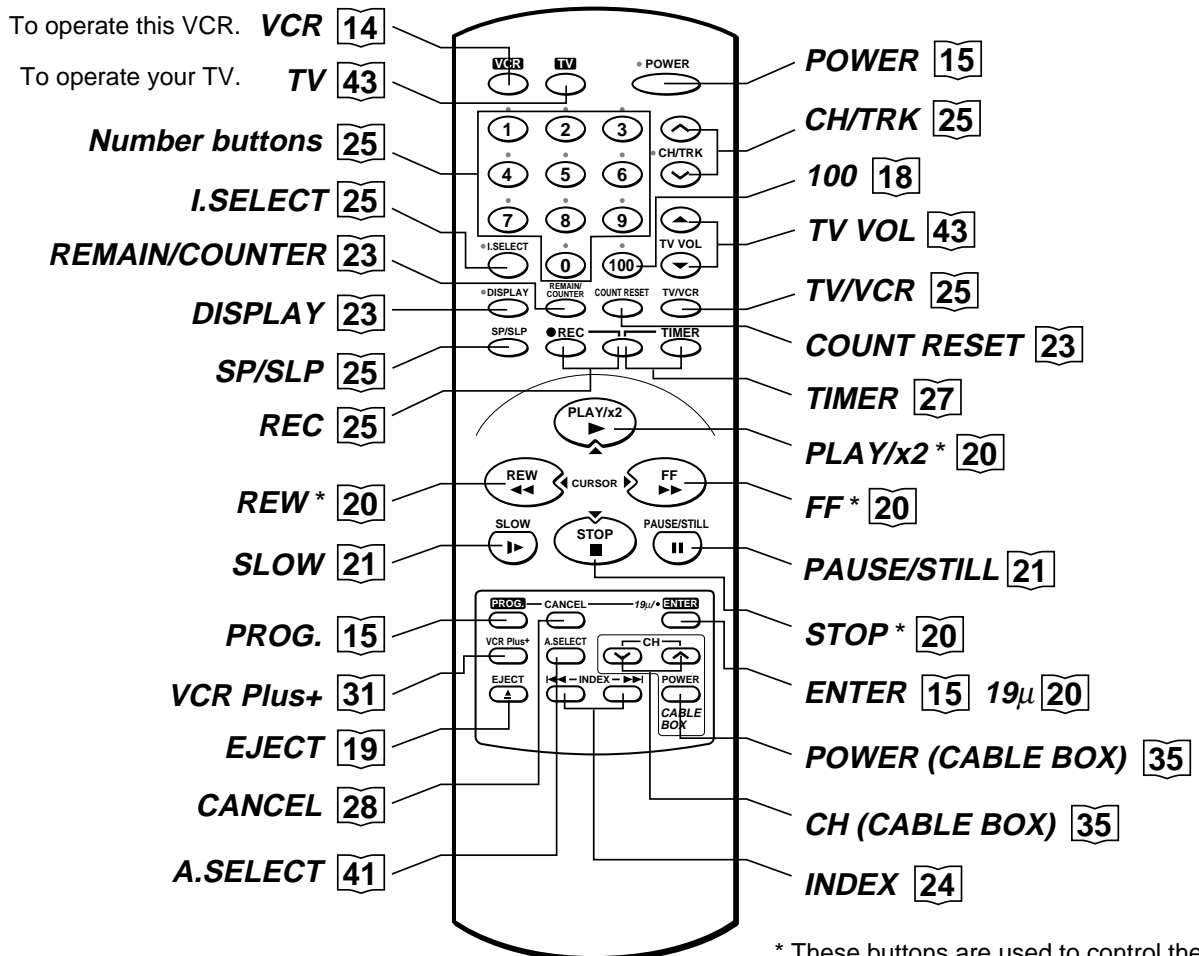

\* These buttons are used to control the cursor on the screen.



**VCR Display**

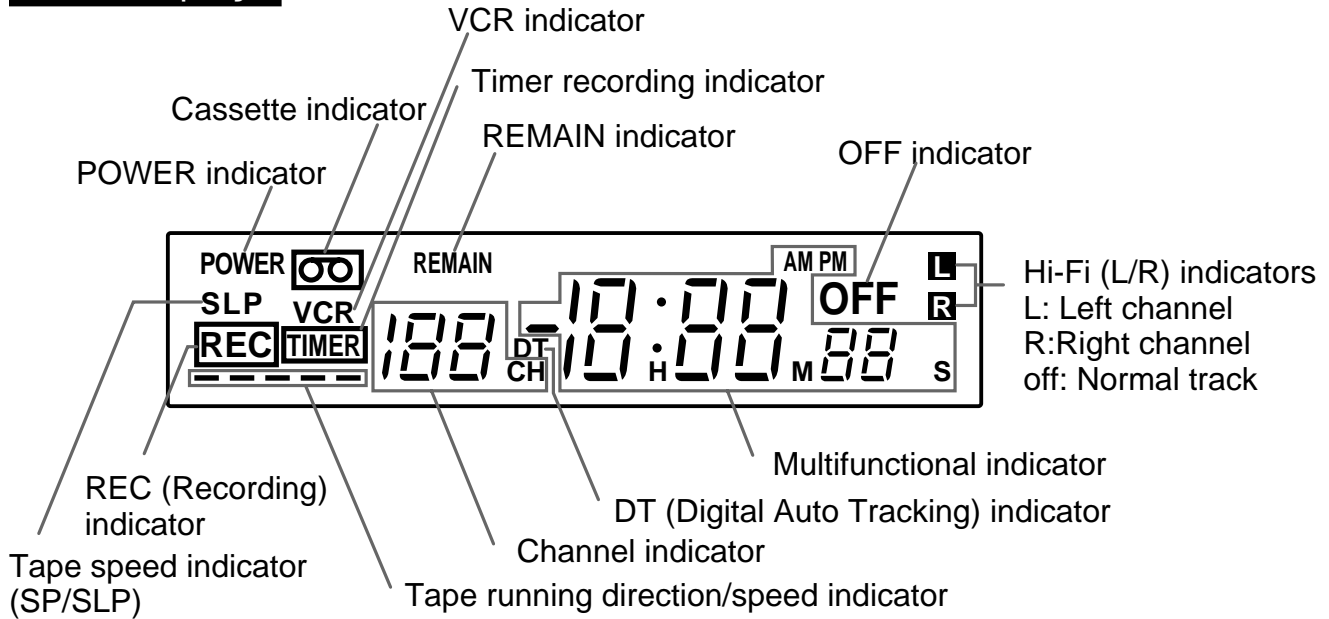

**Rear Panel**

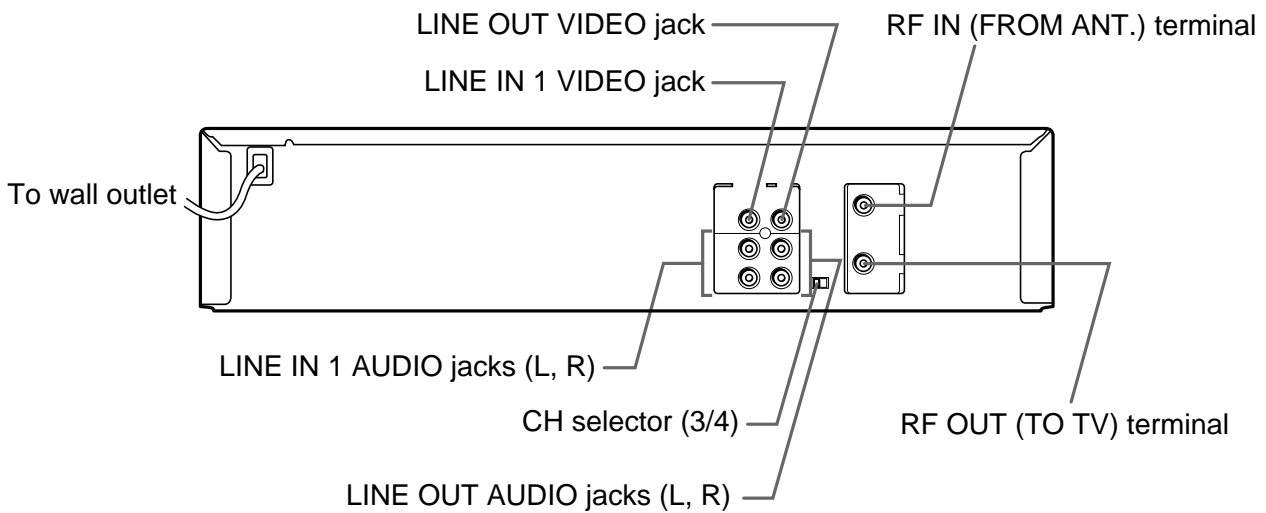

**LINE IN 1 AUDIO (Rear), 2 (Front) jacks**

If the connected equipment is monaural (has one audio output jack), connect the L (MONO) side, the same sound is recorded on both L and R on the Hi-Fi track.

# How to Use the Remote Control

This section explains how to get ready for remote control operation.

## Setting up the Remote Control

- 1 Open the battery compartment lid on the rear panel.

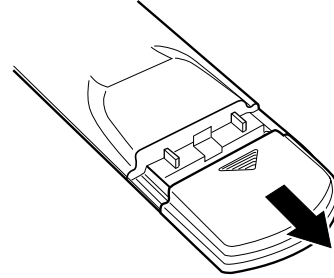

- 2 Install 2 batteries ("AAA" size) following the polarity diagrams.

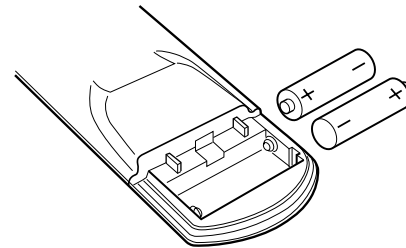

- 3 Close the battery compartment lid.

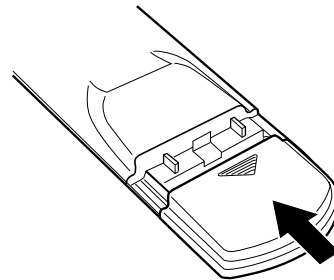

- 4 Point the remote control at the VCR and press the buttons within the operating range.  
 Distance: within about 7 m from the front of the remote sensor  
 Angles: within about 30° in every direction

### Notes on batteries

- The life of the batteries is about 1 year depending on the conditions of use.
- If the remote control does not operate correctly, replace all batteries with new ones.
- If the remote control is not to be used for a long period of time, remove the batteries to avoid possible damage from battery corrosion.

### Caring for the remote control

- Do not expose the remote sensor of the VCR to a strong light source such as direct sunlight or illumination (especially high-frequency lighting) when using the remote control.
- Be careful not to spill water on the remote control or to place it on anything wet, and avoid sharp impacts.

# Connections

Before you use this VCR, it is necessary to connect it to your TV. Several ways of connecting are available depending on your use of TV or cable box. Select one which is applicable to your equipment.

## Antenna/VCR/TV Connection

- 1 Disconnect the antenna cable from your TV and connect it to the **RF IN** terminal on the VCR.
- 2 Connect the **RF OUT** terminal to the TV.

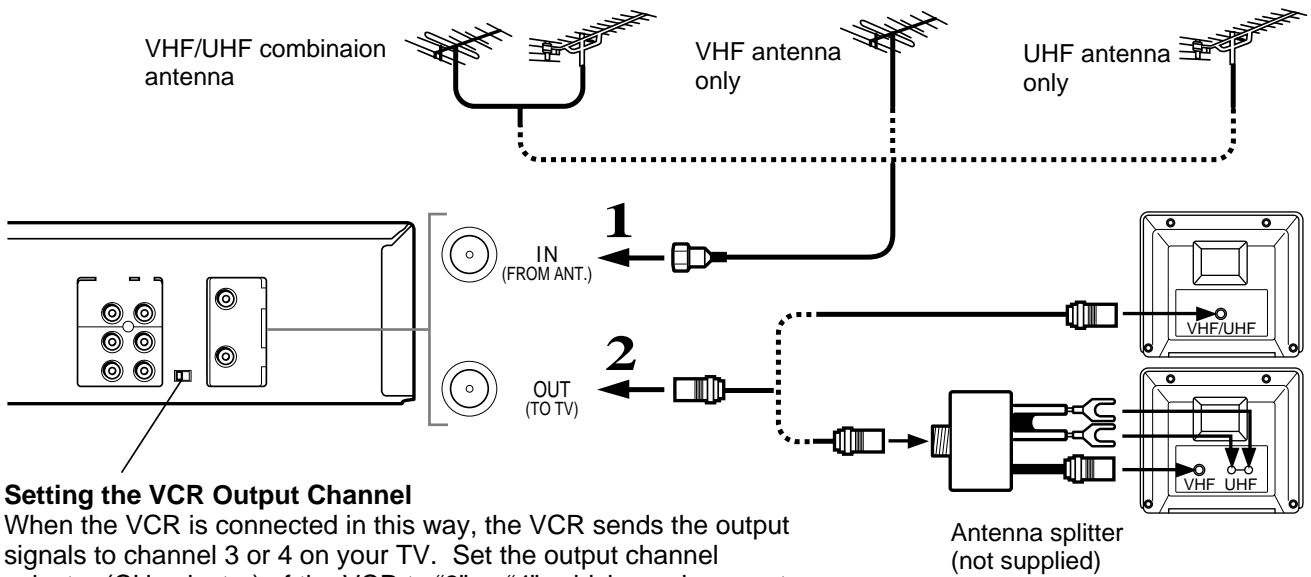

### Setting the VCR Output Channel

When the VCR is connected in this way, the VCR sends the output signals to channel 3 or 4 on your TV. Set the output channel selector (CH selector) of the VCR to "3" or "4", whichever is vacant in your area.

## AUDIO/VIDEO Connections

The AUDIO/VIDEO jacks are also available to connect your TV.

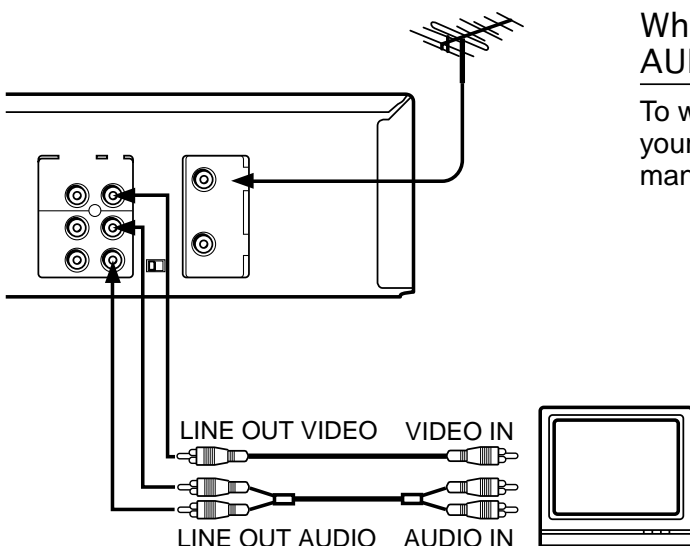

### When connected your TV using the AUDIO/VIDEO OUT jacks

To watch video pictures, set the video input mode on your TV. For the video input mode, refer to the manual of your TV.

## Connections (continued)

### Cable Connection

Choose one of the below according to your usage of the cable box.

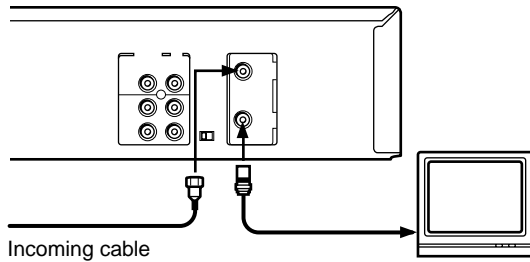

This set-up will enable you to:

- record an unscrambled channel.
- watch an unscrambled channel while recording it.
- record an unscrambled channel while watching another (only when you connect a cable-compatible TV).

You will need to:

- select TV channel 3 or 4 to receive video signals. (See page 11.)
- to record a channel while watching another, press **TV/VCR** on the remote control to turn off the “VCR” indicator in the VCR display and select a desired channel on the TV (only when you connect a cable-compatible TV).

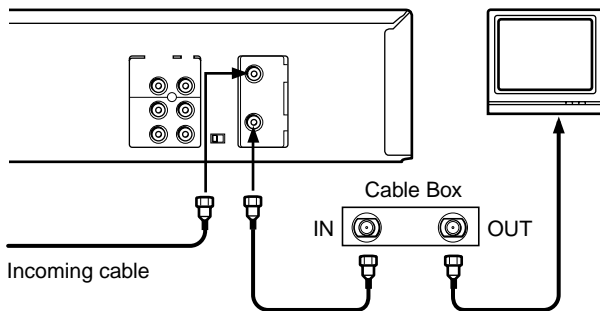

This set-up will enable you to:

- record an unscrambled channel.
- watch an unscrambled channel while recording it.
- record an unscrambled channel while watching another (scrambled or unscrambled).

You will need to:

- set TV channel to the output channel of the cable box.
- turn on the cable box and select cable channel 3 or 4 according to the output channel of the VCR.
- to record a channel while watching another, press **TV/VCR** on the remote control to turn off the “VCR” indicator in the VCR display and select a desired cable channel on the cable box.

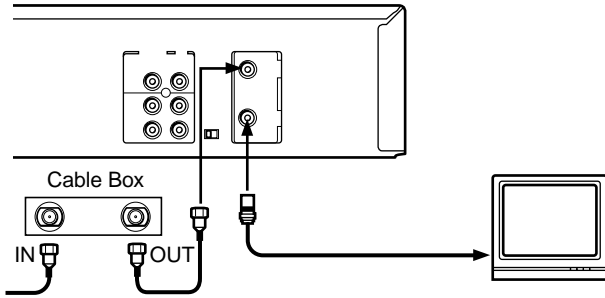

This set-up will enable you to:

- watch an unscrambled or scrambled channel while recording it.
- record any channels through the cable box.

You will need to:

- set TV channel 3 or 4 to receive video signals. (See page 11.)
- set VCR channel to the output channel of the cable box, and select a desired cable channel on the cable box.
- while the VCR is turned off or the “VCR” indicator is not lit in the VCR display, set TV channel to the output channel of the cable box.

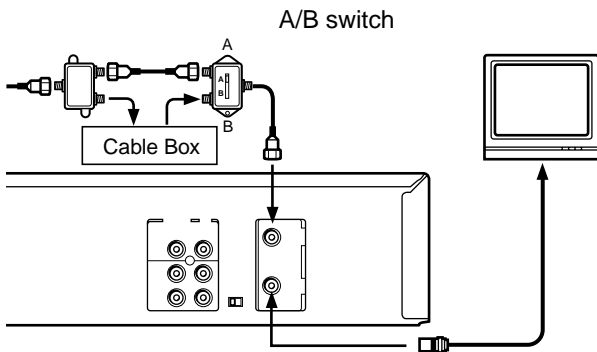

This set-up will enable you to:

- watch an unscrambled or scrambled channel while recording it.
- record an unscrambled channel while watching another unscrambled channel (only when you connect a cable-compatible TV).
- A/B switch “A”: record and watch an unscrambled channel which comes bypassing the cable box.
- A/B switch “B”: record and watch a scrambled or unscrambled channel coming through the cable box.

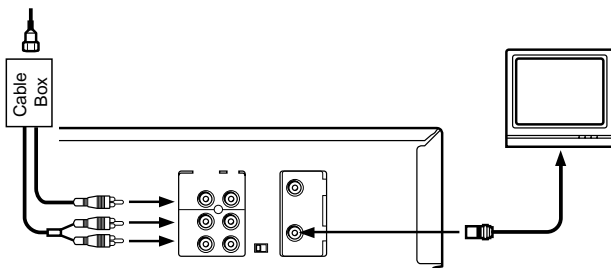

This set-up will enable you to:

- watch or record a channel through the cable box via the LINE IN 1 (AUDIO/VIDEO) jacks.

You will need to:

- press ***I.SELECT*** so that the VCR display shows “L1”.

# Auto Set Up

The Auto Set Up function automatically sets the tuner channels and clock when power is first connected to the VCR.

## Preparation

- Turn on the TV, and select the video channel (3 or 4), or the video input mode if you made the Audio/Video connection (page 11).
- Press *I.SELECT* so that the channel number will appear if “L1” or “L2” is displayed in the VCR display.
- **Press VCR to set the remote control operating the VCR.**

## Auto Set Up

- 1 Connect the antenna cable to the VCR (see page 11). Then connect the VCR's power plug to an AC outlet.  
“Auto” flashes in the VCR display as the VCR automatically tunes in all active stations. When Auto Set Up is completed successfully, the current time will be displayed.

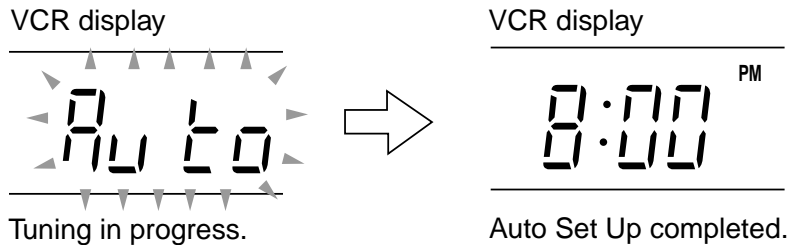

- If the VCR fails to set the clock, “- : -” will be displayed. Set the clock manually. (Refer to “Setting the clock” on page 16.)

## Notes

- If you press the *CANCEL* button, the Auto Set Up is cancelled.
- If Auto Set Up is not performed successfully, perform the clock and Tuner Channel procedures manually (page 16 to 18).
- If, however, you want to add or delete channels, refer to “Adding or erasing channels” on page 18.

# Initial Settings Using On-screen Display

Language selection must be set first when the VCR is first plugged in, or after it encounters a power failure. You can also easily make necessary settings using the on-screen displays.

## Preparation

- Turn on the TV, and select the video channel (3 or 4), or the video input mode if you made the Audio/Video connection (page 11).
- Press **VCR** to set the remote control operating the VCR.

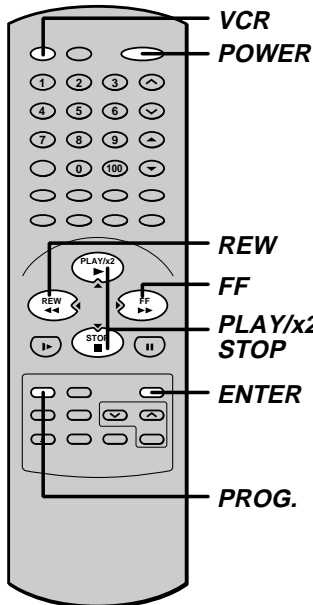

## Setting the Language

**1** Press **POWER** to turn on the VCR.

**2** Press **PROG.**  
The following screen appears on the TV.

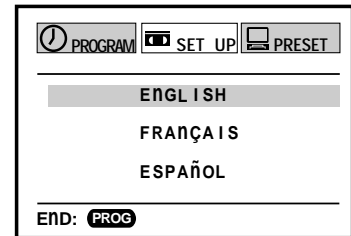

**3** Select the language using **PLAY/x2** (**CURSOR ▲**) or **STOP** (**CURSOR ▼**), and press **PROG.**  
The screen turns to the MENU screen.

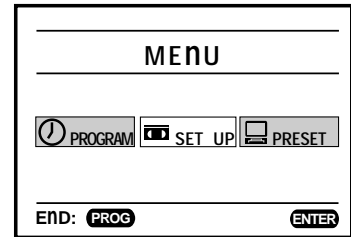

**4** Press **PROG.** to return to the normal TV screen.

## Optional settings on the SET UP screen

Other optional settings can be made. Press **ENTER** while "SET UP" is selected on the MENU screen. The screen turns to the SET UP screen.

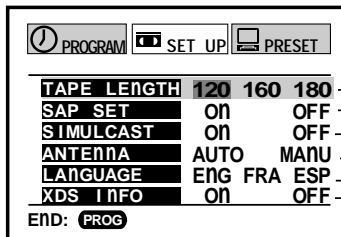

Page 23

Page 41

Page 42

With "AUTO" set, a TV broadcast will appear via the TV tuner after playback.

Move down here, and set to "AUTO" or "MANU".

If you made the Audio/Video connection (page 11), set to "MANU".

To change the language, move down here and set to the desired one.

With "ON" set, you can see the station ID and program title displayed on TV.

To exit, press **PROG.**

## Initial Settings Using On-Screen Display (continued)

### Setting the Clock

Example: To set the clock to 2:30 p.m. on August 25 (summer time) 2000.

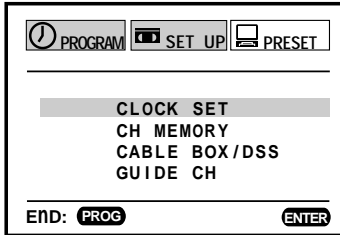
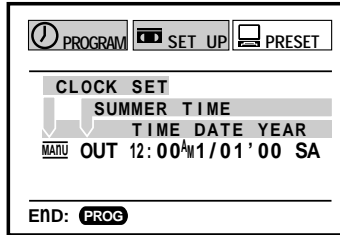
- 1** Press **PROG.**  
The MENU screen appears on the TV.
- 2** Select "PRESET" using **FF** or **REW**, and press **ENTER**.  
A screenshot of the TV's on-screen display menu. At the top, there are three icons: a clock for 'PROGRAM', a TV for 'SET UP', and a remote for 'PRESET'. Below these, the menu items are: 'CLOCK SET' (highlighted), 'CH MEMORY', 'CABLE BOX/DSS', and 'GUIDE CH'. At the bottom, it says 'END: PROG' and 'ENTER'.
- 3** Press **ENTER** to select "CLOCK SET".  
A screenshot of the TV's on-screen display menu. At the top, there are three icons: a clock for 'PROGRAM', a TV for 'SET UP', and a remote for 'PRESET'. Below these, the menu items are: 'CLOCK SET' (highlighted), 'SUMMER TIME' (highlighted), 'TIME DATE YEAR', and 'MANU OUT 12:00M1/01'00 SA'. At the bottom, it says 'END: PROG' and 'ENTER'.
- 4** Select "AUTO" or "MANU" using **PLAY/x2** or **STOP**.  
**AUTO:** The VCR automatically sets or adjusts the clock.  
If you select "AUTO" mode, proceed to step 8.  
**MANU:** You can set the clock manually.  
If you select "MANU" mode, select "SUMMER TIME" using **FF**. Set to "IN" or "OUT" for the summer (daylight saving) time using **PLAY/x2** or **STOP**. (For "IN" and "OUT" selections, see the description in step 9.)
- 5** Move to the next using **FF**.  
(To move back, press **REW**.)
- 6** Vary the digits to set the hour.  
**PLAY/x2:** To increase.  
**STOP:** To decrease.
- 7** Repeat steps 5 and 6 to set the minutes, month, day, and the year (by the last two digits).  
Proceed to step 10 to start the clock.

- 8** Press **ENTER** to start the "AUTO" clock set feature.

After a while, the VCR automatically updates the clock using the data broadcast by the local TV stations.

The following screen will appear on TV depending on the broadcast at your location.

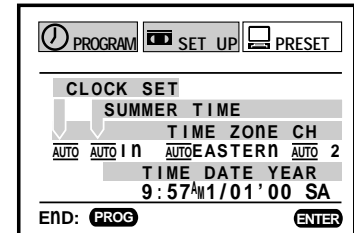

- 9** Select the options using **FF** or **REW**. Change the data using **PLAY/x2** or **STOP**.

- 1) Set "SUMMER TIME (Daylight-Saving Time)".

**IN**, daylight-saving time begins on the first Sunday in April. Because the clock automatically changes from 2:00 AM to 3:00 AM (forward one hour), remember that any part of a scheduled Timer Recording that falls between these two times will not be recorded.

**OUT**, daylight-saving time ends on the last Sunday in October. The VCR clock automatically changes from 2:00 AM to 1:00 AM (back one hour). Therefore, it can affect your recording length if one is set for this time.

- 2) Set "Time Zone".

If you select "AUTO" for your time zone, the VCR sets the clock using the first Coordinated Universal Time information it finds. If the time is not correct, select another time zone or use the "MANU" option.

- 3) Set "CH".

If you don't know the clock data channel, select "AUTO". The VCR will scan automatically to tune the channel carrying the clock data.

If AUTO CLOCK SET is unsuccessful, set the time and date through the "MANU" clock set menu selection.

- 10** Press **PROG.**  
Now the clock starts.

- 11** Press **PROG.** to exit.



# Storing Channels on the VCR

This section is required if you receive only normal TV or unscrambled cable channels, or use a cable box between your TV and the VCR.

## Incoming Antenna/Cable (CATV) Signals

The VCR scans through all receivable TV and CATV channels and stores only the active ones in your area into the memory. Once the storing is finished, you can select a desired channel using *CH/TRK*.

### Preparation

- Turn on the TV, and select the video channel (3 or 4), or the video input mode if you made the Audio/Video connection (page 11).
- Press *I.SELECT* so that the channel number will appear if “L1” or “L2” is displayed in the VCR display.

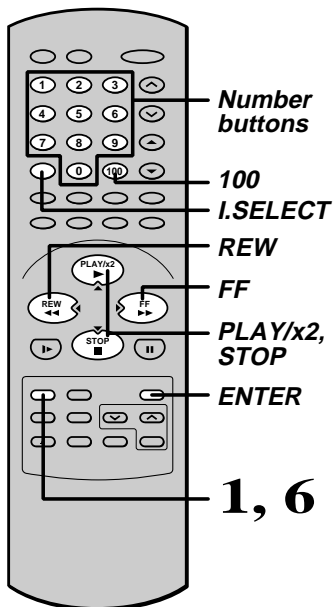

## Incoming Antenna/Cable (CATV) Signals

**1** Press **PROG.** to display the MENU screen.

**2** Select “PRESET” using **FF** or **REW**, and press **ENTER**.

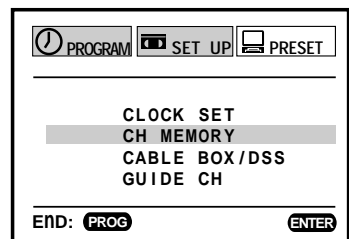

**3** Select “CH MEMORY” using **PLAY/x2** or **STOP**, and press **ENTER**.

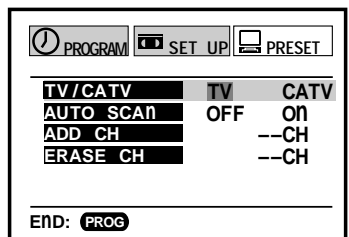

**4** Set “TV/CATV” to “TV” or “CATV” using **FF** or **REW**.

**TV:** To store channels received via the antenna.

**CATV:** To store channels received via the incoming cable.

**5** Select “AUTO SCAN” using **PLAY/x2** or **STOP**, and press **FF** to set to “ON”.

The VCR starts scanning and the channels are stored in the VCR in ascending order. When the scanning is finished, the screen automatically returns.

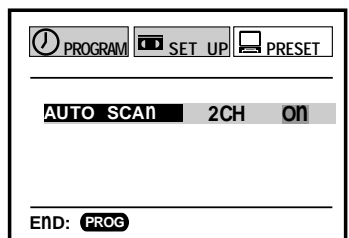

**6** Press **PROG.** to exit.

## Storing Channels on the VCR (continued)

### Adding or erasing channels

#### Adding channels

If a desired channel cannot be scanned automatically because of a weak signal, it can be added to the memory.

#### Erasing channels

You can erase a stored channel from the memory if it is unnecessary.

- 1) Follow steps 1 to 3 of "Incoming Antenna/CATV Signals".
- 2) Select "ADD CH" or "ERASE CH" using **PLAY/X2** or **STOP**.

To add channels

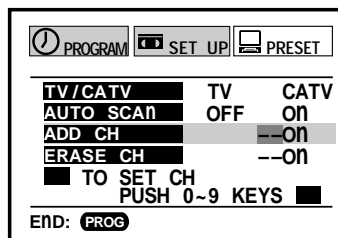

To erase channels

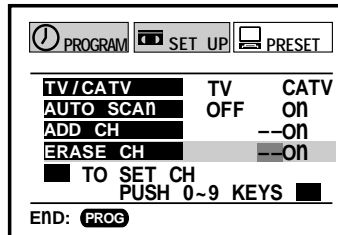

- 3) Enter a channel number of 1 to 125 using **number buttons**.

For more than 100 number, first press **100**.

For CATV channels, refer to the chart below. (For other orders, check with your cable company.)

- 4) Repeat steps 2) and 3) to add or erase channels as necessary.

- 5) Press **PROG.** to exit.

### Selecting stored channels

Once the active channels have been stored, you can select the channels in two ways below.

#### Number buttons

To enter digits of the channel number.

- For one-digit number, enter 0 before.
- For more than 100 number, first press **100**.
- Each **number button** needs to be pressed within 2 seconds.

#### CH/TRK

To shift up or down the stored channel numbers.

### Channel reference chart

Number on the VCR		TV										CATV																																										
Corresponding channel number		STD (HRC/IRC)										STD (HRC/IRC)																																										
10	11	12	13	14	15	16	17	18	19	20	21	22	23	24	25	26	27	28	29	30	1	2	3	4	5	6	7	8	9	1	2	3	4	5	6	7	8	9																
10	11	12	13	14	15	16	17	18	19	20	21	22	23	24	25	26	27	28	29	30	1(A-8)	2	3	4	5(A-7)	6(A-6)	7	8	9	1(A-8)	2	3	4	5(A-7)	6(A-6)	7	8	9																
31	32	33	34	35	36	37	38	39	40	41	42	43	44	45	46	47	48	49	50	51	A	B	C	D	E	F	G	H	I	J	K	L	M	N	O	P	Q	A	B	C	D	E	F	G	H	I	J	K	L	M	N	O	P	Q
31	32	33	34	35	36	37	38	39	40	41	42	43	44	45	46	47	48	49	50	51	AA	BB	CC	DD	EE	FF	GG	HH	II	JJ	KK	LL	MM	NN	OO	AA	BB	CC	DD	EE	FF	GG	HH	II	JJ	KK	LL	MM	NN	OO				
52	53	54	55	56	57	58	59	60	61	62	63	64	65	66	67	68	69	70	71	...	UU	VV	WW	XX	YY	ZZ	AAA	BBB	65	66	67	68	69	70	71	...	UU	VV	WW	XX	YY	ZZ	AAA	BBB	65	66	67	68	69	70	71	...		
93	94	95	96	97	98	99	100	101	102	103	...	121	122	123	124	125	A-5	A-4	A-3	A-2	A-1	100	101	102	103	...	121	122	123	124	125	A-5	A-4	A-3	A-2	A-1	100	101	102	103	...	121	122	123	124	125								

#### CATV signals

- STD (standard) cable TV signals
  - HRC (Harmonic Related Carriers) cable TV signals
  - IRC (Incremental Related Carriers) cable TV signals
- IRC is also called ICC (Incremental Coherent Carriers)

# Video Cassette Use

## Video Cassette Use

### Loading a cassette

Push the cassette into the cassette compartment with the window side facing up and the label side towards the front. The VCR is automatically turned on. The  indicator will appear in the VCR display.

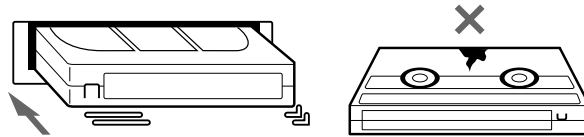

### Ejecting a cassette

Press **EJECT**. The cassette is ejected from the cassette compartment.

#### Warning

Do not insert your hands or any foreign objects into the compartment. This may result in injury or damage. Take special care with children to avoid accidents.

### Precautions when using video cassettes

Video cassettes have a safety tab to prevent accidental erasure. If the tab has already been removed, recording cannot be performed.

#### To prevent accidental erasure

Remove this safety tab with a screwdriver.

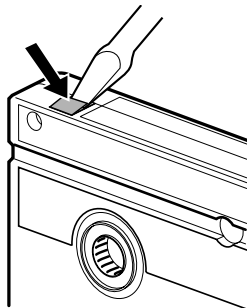

#### To record again

Cover the tab hole with adhesive tape.

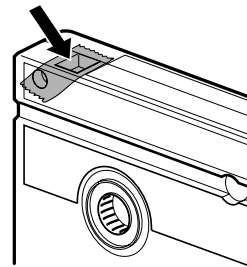

- Avoid exposing cassettes to direct sunlight. Keep them away from heaters. Avoid extreme humidity, vibrations or shock, strong magnetic fields (near a motor, transformer or magnet) and dusty place.

# Playback

This section explains the basic playback operation.

## Preparation

- Select the video channel (3 or 4) or video input mode on the TV.
- Press **VCR** to set the remote control operating the VCR.

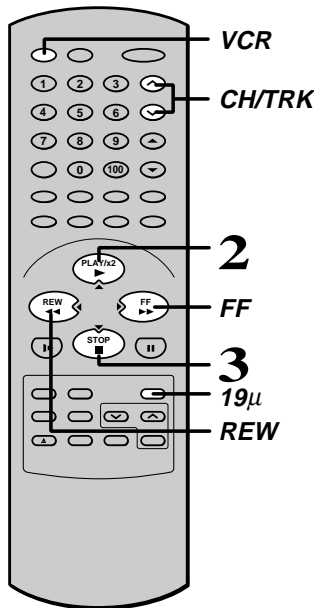

## Basic Playback

- 1 Load a recorded cassette.  
Power is turned on.  
If the cassette has no safety tab, playback starts automatically.
- 2 Press **PLAY/x2** to start playback.
- 3 To stop playback, press **STOP**.

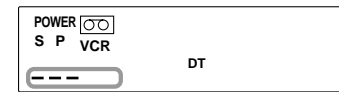

Rewinding / Fast-forwarding  
Press **REW** or **FF** in the stop mode.

## Adjusting the tracking

When playback starts, the VCR automatically adjusts the tracking for clear pictures and sound (Digital Auto Tracking). The "DT" indicator blinks during the adjusting.

If the VCR cannot locate the best possible tracking point, hold down one of **CH/TRK** to adjust the tracking manually.

- To resume the digital auto tracking, hold down both **CHANNEL** on the VCR simultaneously for about 2 seconds.

## Notes

- During the adjusting, the playback picture and sound may be distorted.
- The digital auto tracking is activated only in the playback mode.
- To reset the manual tracking point to the center, press both **CHANNEL** on the VCR simultaneously for not longer than 1 second.
- The noise on the screen may not be completely eliminated depending on the tape used, especially when the tape was recorded on another VCR.

## 19μ HEAD

You can view high quality pictures while playing back a tape recorded in the SLP tape speed.

By pressing **19μ** repeatedly, the 19μ HEAD mode is displayed on the TV screen as follows:

**19U-HEAD AUTO:** Usually set to "AUTO". As the playback starts, the VCR automatically activates the 19μ head and reproduces high quality pictures.

**19U-HEAD OFF:** Set to "OFF" if the pictures are marred by dots.

## Note

During playback with the 19μ head, momentary noises or shakes may be produced when you change the mode to the picture search or variable speed playback.

# Variable Speed Playback

You can play back a tape at various tape speeds.

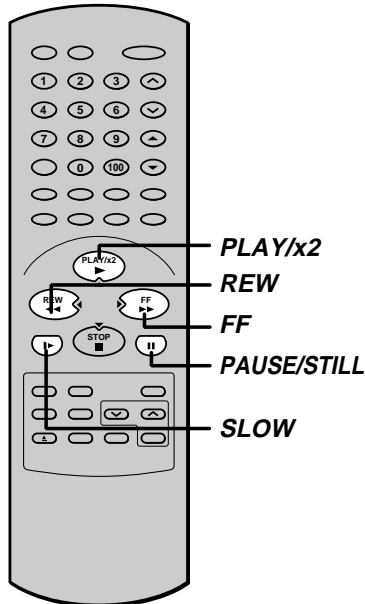

## Picture Search

A tape runs at 5 times or 7 times the normal playback speed so that you can quickly locate a particular scene.

- 1** Press **FF** or **REW** during playback.  
The tape runs at 5 times the normal playback speed.
- 2** To change the tape speed to 7 times the normal playback speed, press and hold **FF** or **REW**.  
If you release it, the tape speed returns to 5 times.

### Note

If you press **FF** or **REW** during picture search, the mode changes to fast-forwarding or rewinding.

To resume normal playback  
Press **PLAY/x2**.

## Still Picture

A picture freezes so that you can watch closer.

- 1** Press **PAUSE/STILL** during playback.  
The picture freezes.

To resume normal playback  
Press **PAUSE/STILL**.

### Notes

- The still mode is automatically cancelled after about 5 minutes and returns to normal playback.
- The still picture may shake if a picture of a fast-moving object or scene is frozen. This is not a defect in the unit.

## Adjusting Still Picture Stability

If the still picture is distorted or flickers, hold down one of **CH/TRK** until the picture becomes stable.

### Note

The distortion of the still picture may not be eliminated completely.

### Note

When playing back a tape which is recorded in S-VHS format, distortion may occur during the variable speed playback.

## Slow-motion Picture

The tape runs at 1/7th or 1/15th the normal playback speed.

- 1** Press **SLOW** during playback.  
The tape runs at about 1/7th the normal playback speed.  
Each time you press **SLOW**, the speed alternates between 1/7th and 1/15th.

To resume normal playback  
Press **PLAY/x2**.

### Notes

- The slow-motion picture mode is automatically cancelled after about 5 minutes and returns to normal playback.
- The slow-motion picture may flicker up and down. This is not a defect in the unit.

## Adjusting the Tracking Manually

If the slow-motion picture is noisy, hold down one of **CH/TRK** until the best picture is obtained.

### Note

The noise in the slow-motion picture may not be eliminated completely.

## Variable Speed Playback (continued)

### Frame Advance

A picture advances frame by frame.

- 1 Press **PLAY/x2** during still playback. Each time you press **PLAY/x2**, the picture advances one frame. If you press and hold **PLAY/x2**, the tape runs at 1/30th the normal playback speed.

To resume normal playback  
Press **PAUSE/STILL**.

### Double Speed Playback

A tape runs at twice the normal speed.

- 1 Press **PLAY/x2** during playback. The picture runs at twice the normal playback speed.

To resume normal playback  
Press **PLAY/x2**.

## Shuttle Dial Operation

You can also activate the picture search and slow playback at various speeds by turning the shuttle dial on the VCR.

- 1 Turn the **shuttle dial** on the VCR.

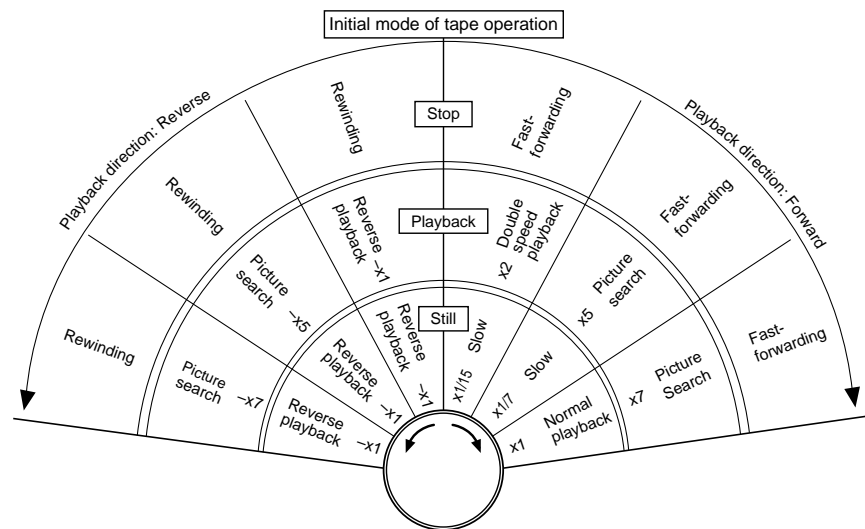

The playback speeds differ depending on the recording tape speed of the tape as follows.

	Picture search		Reverse playback
SP:	x5	x7	-x1
SLP:	x15	x21	-x3

### Notes

- The still picture mode will be released automatically after about 5 minutes and forward playback will start.
- Fast-forwarding or rewinding started from the stop mode continues even if the *shuttle dial* is released. To stop, press **STOP**.
- The reverse playback mode will be released automatically after about 25 seconds and forward playback will start.
- Noise bar may appear in reverse playback.

### Note

If you playback a tape recorded in the SLP tape speed or a tape recorded on another VCR in various speed mode, the picture may be noisy or monochrome.

# Useful Functions in Tape Operation

These functions will help your playback.

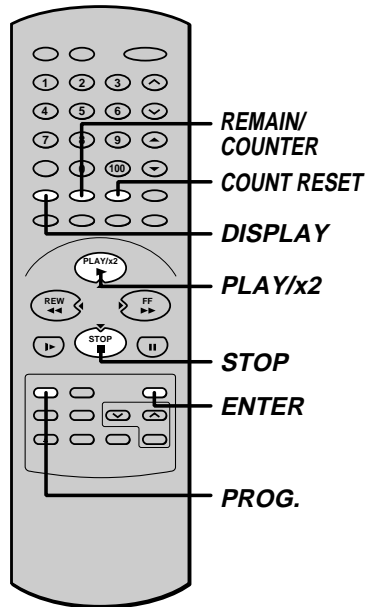

## S-VHS Quasi Playback (SQPB)

- This VCR can also play back a tape which is recorded in S-VHS format. But the playback picture does not have the same quality and resolution as the original S-VHS playback picture.
- This VCR cannot record in S-VHS format.

\* SQPB is an abbreviation for S-VHS Quasi Playback.

## Counter Function

You can view the clock, linear time counter or tape remaining time in the VCR display or on the TV screen.

- 1 Each time you press **REMAIN/COUNTER**, the VCR display changes in sequence as follows:

→ Linear time counter (HMS) → Tape remaining time (REMAIN/RT) → Clock

The indication above will also appear on the TV screen by pressing **DISPLAY**. They are switchable with **REMAIN/COUNTER**.

To reset the linear time counter to “0H00M00S”

The counter is automatically reset to “0H00M00S” when a cassette is ejected. If you want to reset at another point, such as the beginning of a new recording, just press **COUNT RESET**.

### Notes

- The linear time counter does not work on non-recorded portions on the tape.
- When the tape is ejected or the VCR is turned off, the display changes to clock.
- If the tape rewinds back over “0H00M00S”, “-” appears in the VCR display.
- The displayed time of the linear time counter is only an approximation.

## Tape Remaining Time

To view the tape remaining time in the VCR display, select the tape length beforehand.

- 1 Turn on the VCR and load a cassette.
- 2 Press **PROG.** to display the MENU screen.
- 3 Select “SET UP” using **FF** or **REW**, and press **ENTER**.
- 4 Select the length of the tape.  
**T120**: for a T-120 tape or shorter  
**T160**: for a T-140 or T-160 tape  
**T180**: for a T-180 tape

PROGRAM	SET UP	PRESET
TAPE LENGTH	120 160 180	
SAP SET	ON	OFF
SIMULCAST	ON	OFF
ANTENNA	AUTO	MANU
LANGUAGE	ENG	FRA ESP
XDS INFO	ON	OFF
END:	PROG	

(Continued)

## Useful Functions in Tape Operation (continued)

**5** Press **PROG.** to exit.

**6** Press **REMAIN/COUNTER.**

The remaining time ("RT - : -") appears in the VCR display.

### Notes

- The displayed remaining time is an approximation.
- The remaining time is calculated according to the tape speed (SP or SLP) and the cassette type.

## Index Search Function

The VCR can find a point where a registered index signal is on a tape and play back for about 5 seconds. You can easily locate the desired program by inputting the index signal.

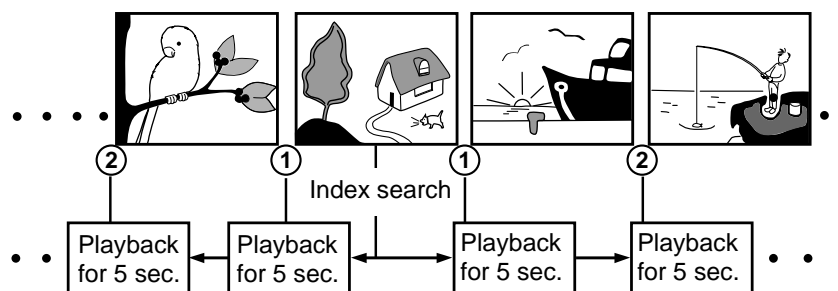
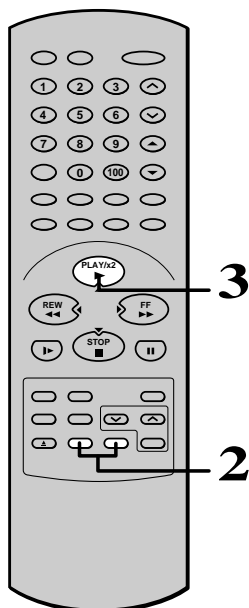

### Registering index signals

Each time a recording starts, an index signal is automatically registered. To register it somewhere else, press **INDEX** f during recording.

### Note

A certain interval is required between the index signals: more than 1 minute in the SP tape speed and more than 3 minutes in the SLP tape speed.

### Index search

**1** Load a cassette with the index signals registered.

**2** Press **INDEX** in the stop or playback mode.

g INDEX: To search in the reverse direction.

INDEX f: To search in the forward direction.

The VCR fast-forwards or rewinds the tape. When an index signal is found, the VCR plays back the tape for about 5 seconds, and then resumes fast-forwarding or rewinding. This is repeated each time at an index signal.

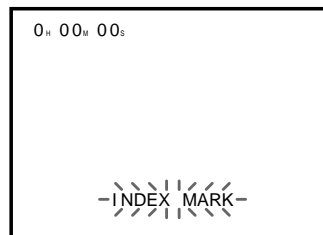

**3** Press **PLAY/x2** when the desired program is found.

Normal playback starts.

### Notes

- At the very beginning of the tape, the index search may not work properly.
- If you registered the index signals on a tape recorded on another VCR, the recording may be blurred at the index point and the index search may not work properly.



# Recording a TV Program

This section explains the basic recording operation.

## Preparation

- Select the video channel (3 or 4) or video input mode on the TV.
- If you record cable channels via the cable box, finish the cable box set-up (pages 33-36), and turn on the cable box.

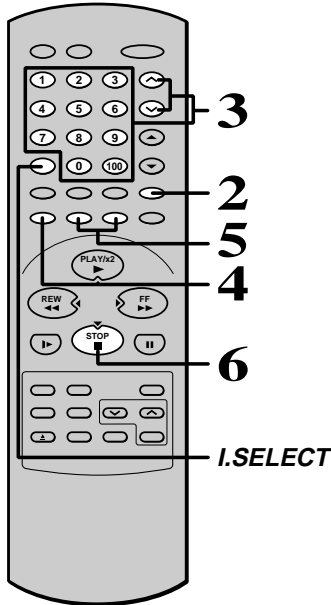

## To record from other connected equipment

In step 3, press **I.SELECT** to switch the display as follows:

**L1**: To record via the LINE IN 1 jacks on the rear panel.

**L2**: To record via the LINE IN 2 jacks on the front panel.

## Basic Recording

**1** Load a cassette with the safety tab attached.

**2** Press **TV/VCR** so that the “VCR” indicator appears in the VCR display.

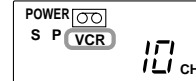

**3** Select a channel to record with **CHANNEL** on the VCR, or **CH/TRK** or **number buttons** on the remote control.

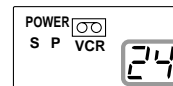

If you see “L1” or “L2” in the VCR display, press **I.SELECT** so that the channel number appears.

- If you record cable channels via the cable box, make the output channel number of the cable box or “L1” appear, depending on your connection. (See pages 11 – 13.)

**4** Press **SP/SLP** to select the recording tape speed.

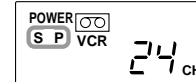

**SP**: Suitable for general recording with better picture and sound quality.

**SLP**: Suitable for tripling recording time, but with less picture and sound quality than using the SP tape speed.

**5** Press **REC** on the VCR, or simultaneously press both **REC** on the remote control.

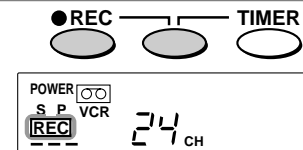

Recording starts.

**6** Press **STOP** to stop recording.

## Watching a TV program while recording another

- 1) While recording, press **TV/VCR** to turn off “VCR” indicator.
- 2) Choose another channel using the channel selector on the TV.

## Skipping unnecessary scenes while recording

Press **PAUSE/STILL** to stop recording momentarily. To resume recording, press **PAUSE/STILL** again.

### Note

The VCR automatically shifts to the stop mode if the recording pause mode continues for 10 minutes.

## Recording off time setting

By setting the recording off time, the recording stops and the VCR is turned off automatically.

While recording, press **REC** on the VCR repeatedly to set the desired off time.

Each time you press **REC**, each half-hour up to about 4 hours later and “- : -” appear cyclically.

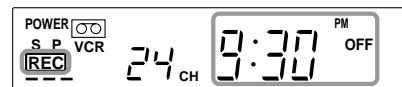

### Notes

- To cancel the recording in progress, press **STOP**.
- If the VCR clock is not set, this function will not activate.

# Timer Program Recording

The programmable timer allows you to record up to 6 different programs over one month.

## Preparation

- Select the video channel (3 or 4) or video input mode on the TV.
- Make sure that the clock is set correctly (page 16).
- Store the channels on the VCR (pages 17 and 18).
- If you record cable channels, finish the cable box set-up (pages 33 – 36), and turn on the cable box.
- If you record satellite channels, finish the DSS® satellite receiver set-up (pages 37 – 40), and turn on the DSS® satellite receiver.

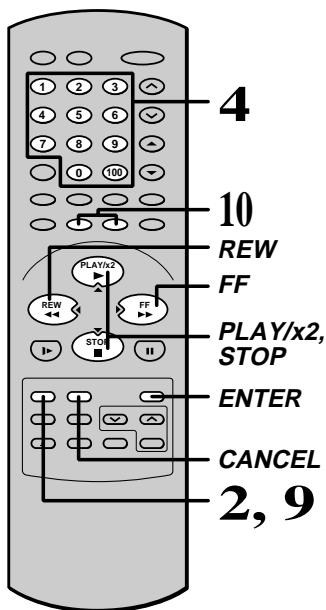

## Timer Programming Procedure

**Example:** To record cable channel 25 in the SP tape speed from 9:30 p.m. until 10:00 p.m. on August 30. Today is August 25.

- 1 Load a cassette with the safety tab attached.
- 2 Press **PROG.** to display the MENU screen.
- 3 Select “PROGRAM” using **FF** or **REW**, and press **ENTER**.

	PROGRAM	SET UP	PRESET
	CH	DATE	ON OFF SPD
●	--	---	---
●	--	---	---
●	--	---	---
●	--	---	---
●	--	---	---
●	--	---	---

END: PROG

- 4 Move to the next using **FF**, and enter the channel number 25 by using **PLAY/x2**, **STOP** or **number buttons**.

	PROGRAM	SET UP	PRESET
	CH	DATE	ON OFF SPD
●	25	-/-	---
●	--	---	---
●	--	---	---
●	--	---	---
●	--	---	---
●	--	---	---

END: PROG

- To record a cable program from the connected cable box:  
Enter the cable channel number by **number buttons**, **PLAY/x2** or **STOP**.  
If your cable box is not remote-controllable, choose the desired channel (1 to 125) on the cable box.
- To record a satellite program from the connected DSS® satellite receiver:  
Enter the satellite channel number (100 to 999) by **number buttons**, **PLAY/x2** or **STOP**. (If a number 1 to 99 is entered, the VCR will record a TV/CATV program on the channel, not a satellite’s.)  
If your DSS® satellite receiver is not remote-controllable, choose the desired channel (100 to 999) on the DSS® satellite receiver.

**To make corrections:**  
Press **REW** to move back to the item, or **FF** to forward.

- 5** Move to the next using **FF**, and set the recording date using **PLAY/x2** or **STOP**.

The date changes as follows:

→ 8/25 → 8/26 → ... → 9/24 → WKLYSU → ...  
MO~FR ← WKLYSA ←

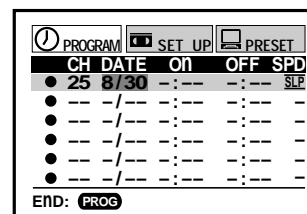

**[WKLYSU]...[WKLYSA]:** You can record TV programs on the same channel on the day and time every week.

**[MO~FR]:** You can record TV programs on the same channel on the day and time Monday through Friday.

- 6** Move to the next using **FF**, and set the hour and minutes of the recording start time.

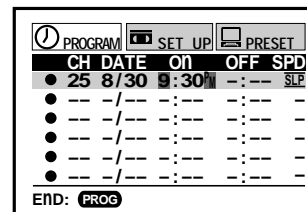

- 7** Move to the next, and set the recording off time.

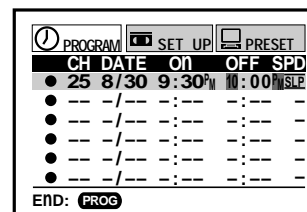

- 8** Move to the next, and select the tape speed (SP) using **PLAY/x2** or **STOP**.  
For the tape speed "AUTO (Auto Speed Select)", see below.  
To set another program, press **FF**, and select the next line pressing **STOP**.

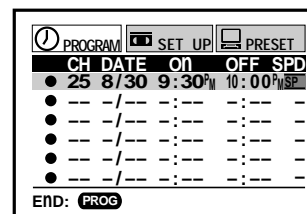

Repeat steps 4 to 8.

- 9** Press **PROG**.  
Now programming is completed.

- 10** Press both **TIMER** simultaneously.  
The power turns off and the VCR enters the timer standby mode.

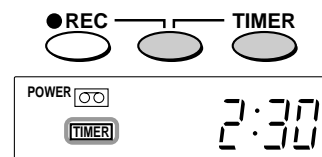

## Auto Speed Select

If you are not sure the tape is long enough for timer program recording in the SP tape speed, set the recording tape speed to "AUTO".

Recording starts in the SP tape speed and the VCR automatically selects the tape speed to record the program to the end. If the tape length is not long enough, the tape speed automatically changes from SP to SLP.

## Notes

- Make sure that the tape length is selected correctly according to the tape used on the SET UP screen (page 23).
- When the SLP tape speed is selected and the tape length is not sufficient to record the program to the end, the program cannot be recorded to the end.
- The picture will be distorted when playing the part where the recording tape speed is switched from SP to SLP with the Auto Speed Select feature.

(Continued)

## Timer Program Recording (continued)

Confirming the timer programs  
(in the timer standby mode)

Press **PROG.**

The screen for confirming will appear.

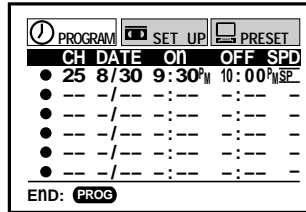

After about 30 seconds, the screen disappears.

## Changing/cancelling the timer programs

- 1) If the **TIMER** indicator is lit, press both **TIMER** to turn it off, and then turn the VCR on by pressing **POWER**.
- 2) With steps 2 to 9, change the items.  
To cancel a program, select the program you want to cancel in step 4, and press **CANCEL**. The line is then cleared.
- 3) Press both **TIMER** to return to the timer standby mode.

## Recording or playback in the timer standby mode

First press both **TIMER** to release the timer standby mode, and then press **POWER** to turn on the VCR. The VCR will be available for use.

- Be sure to press both **TIMER** again to return the VCR to the timer standby mode after you are finished.

## Error indication

The "E" (Error) indicator appears in the VCR display if you press both **TIMER** when:

- a cassette is not loaded.
- the loaded cassette has no safety tab.
- no timer program is set.

In these cases, a recording can not be made.

If a power failure occurs during the timer program recording (including VCR Plus+ C<sup>3</sup>® system recording (page 31))

- When a power failure has occurred, "- :- -" appears in the VCR display. Since the programmed contents have been cleared, reset the clock and timer programming.
- When power has failed for a short time, the colon of the current time display blinks. The programmed contents are not affected. Reset the clock.

## Overlaps of the programs

If two timer programs overlap, the recording start time of program 2 has priority over the recording off time of program 1.

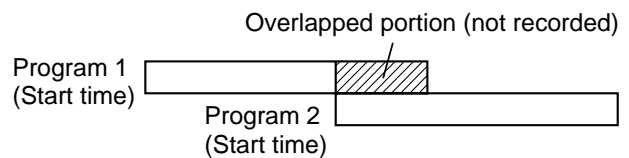

# VCR Plus+ C<sup>3</sup>® system *Set-up*

VCR Plus+ C<sup>3</sup>® system is a timer recording system for an easier programming that requires you only to enter a PlusCode® programming number assigned to a desired program. This section explains the necessary set-up to make VCR Plus+ C<sup>3</sup>® system recordings.

The flow chart below will give you an idea as to what must be done to use the VCR Plus+ C<sup>3</sup>® system feature.

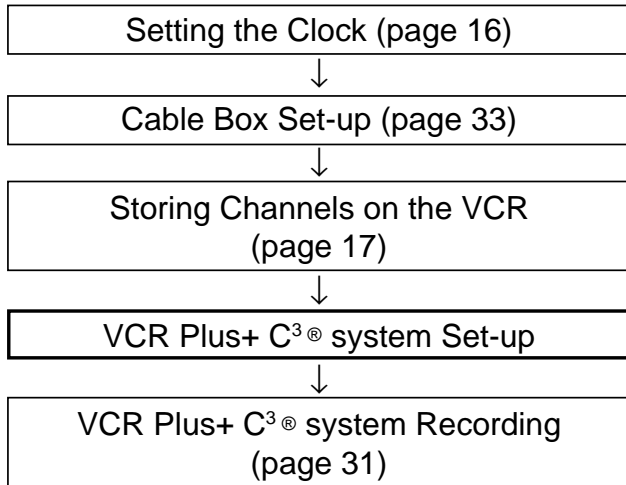

\* With the VCR Plus+ C<sup>3</sup>® system, this video cassette recorder can automatically select the appropriate channel on your compatible cable box or satellite receiver. VCR Plus+, C<sup>3</sup> and PlusCode are registered trademarks of Gemstar Development Corporation. The VCR Plus+ system is manufactured under license from Gemstar Development Corporation.

You must give the VCR the special numbers for guide channels (also called VCR Plus+® system channel numbers) assigned to each channel that you receive in your home. The VCR identifies the channel to be recorded by the guide channel number you enter.

The guide channel numbers are published in TV guide magazine, selected local TV publications, or the channel guide from cable company. If you cannot find the numbers, call Gemstar's customer service department at 1-800-4321-VCR.

Sample of a Guide channel chart from a local TV listing

VCR Plus+® SYSTEM CHANNEL NUMBERS			
Broadcast channels	Assigned channels	Cable channels	Assigned channels
3 KCRA (NBC).....	3	A & E.....	39
6 KVIE (PBS).....	6	AMC.....	35
10 KXTV (CBS).....	10	BET.....	57
13 KOVR (ABC).....	13	BRAV.....	54
19 KCSO (SPAN).....	19	CMTV.....	14
31 KRBK (IND).....	31	CNBC.....	23
40 KTXL (FOX).....	40	CNN.....	42
58 KSCH (IND).....	25	C-SPAN.....	28
44 KBHK (IND).....	15	CUNY.....	29
24 KCPM (NBC).....	24	DIS.....	53
4 KRNV (NBC).....	28	ESPN.....	34
42 KFCB (IND).....	27	FAM.....	47
7 KGO (ABC).....	28	HBO.....	33

RECORDING

Sample of a Channel line-up chart from a cable-TV company

CHANNEL LINE-UP CHART	
Channel 2	ME/U
Channel 3	8 WISH
Channel 4	4 WTTV
Channel 5	6 WRTV
Channel 6	VCA/Local origination
Channel 7	HOME BOX OFFICE
Channel 8	A.P News Plus
Channel 9	9 WGN.

## VCR Plus+ C<sup>3</sup>® system Set-up (continued)

### Preparation

- Select the video channel (3 or 4) or video input mode on the TV.
- If you record cable channels, finish the cable box set-up (pages 33 – 36).
- Prepare the list like below.

Example

Station	Guide channel number (on the TV Guide, local TV listings etc.)	Your home channel number (on the channel line-up chart supplied by cable companies)
HBO	33	7
ESPN	34	
AMC	35	

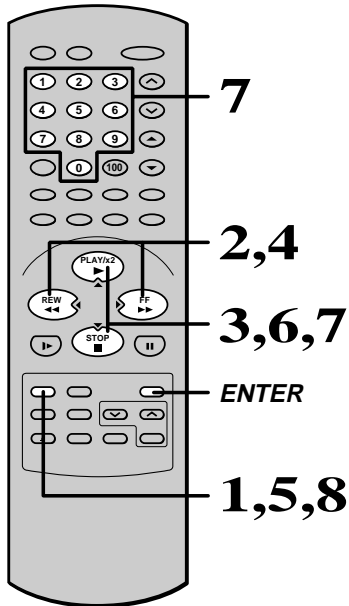

## Guide Channel Setting

- 1 Press **PROG.**
- 2 Select "PRESET" using **FF** or **REW**, and press **ENTER**.
- 3 Select "CH MEMORY" using **PLAY/x2** or **STOP**, and press **ENTER**.
- 4 Set "TV/CATV" to "TV" or "CATV" using **FF** or **REW**.
- 5 Press **PROG.** to return to the PRESET screen.
- 6 Select "GUIDE CH" using **PLAY/x2** or **STOP**, and press **ENTER**.  
(the case of CATV mode)
- 7 Enter channel numbers on the right of the guide channel numbers.  
Find a guide number you marked on the list using **PLAY/x2** or **STOP**, and enter the corresponding home channel number if necessary by using **number buttons**.  
**Example:** To enter home channel number 7 (HBO) with guide channel number 33 assigned.  
In some areas, one channel may be assigned more than one guide channel number. In this case, enter the home channel number to each of the guide channel numbers.
- 8 Press **PROG.** to exit.  
The set-up is all over and your VCR Plus+ C<sup>3</sup>® system recording is now available.

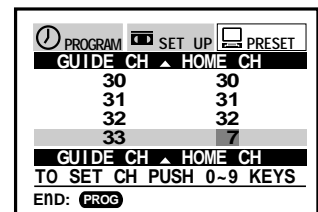
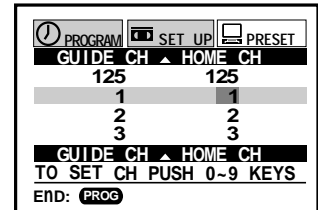

### Notes

- When your cable company changes the channel line-up, you must re-do this set-up for the channel.
- The VCR Plus+ C<sup>3</sup>® system feature does not work on programs from a connected DSS® satellite receiver.

# VCR Plus+ C<sup>3</sup>® system *Recording*

After performing the VCR Plus+ C<sup>3</sup>® system set-up, you can easily program a recording simply by entering the PlusCode® programming number. The numbers are published in the TV listings of newspapers, TV guide magazine, etc.

## Preparation

- Make sure that the clock is set correctly (page 16).
- Load a cassette with a safety tab.

### For cable box users:

- Finish the cable box set-up (pages 33 – 36), and turn on the cable box.

### For DSS® satellite receiver users:

- This VCR cannot record satellite programs with the VCR Plus+ C<sup>3</sup>® system feature. To make an unattended recording of satellite programs, see “Timer Program Recording” (pages 26 – 28).

Sample of TV program listing in a TV guide magazine

5PM **FAM** POPEYE — Cartoon 725692  
**HBO** MAKING OF A CHAMPION 237945  
 A look at gymnast and Olympic hopeful Kim Zmeskal from novice to seasoned competitor.  
**NIK** HEY DUDE — Children (793571) ← PlusCode® programming number  
 One of Ted's teachers stays at the ranch.  
**USA** MY TWO DADS — Comedy (586858) ← PlusCode® programming number  
 5:35 **TBS** GOOD TIMES — Comedy 2261858

RECORDING

## VCR Plus+ C<sup>3</sup>® system Programming

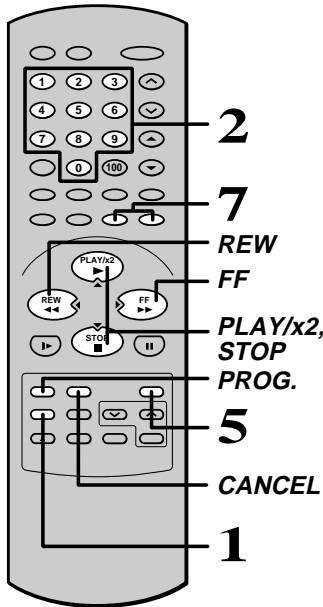

**1** Press **VCR Plus+**.  
The VCR Plus+ screen appears.

**2** Enter a PlusCode® programming number.

**Example:** To record a program with the PlusCode® programming number 36295 (fictitious code).

Press **number button 3, 6, 2, 9 and 5**.

Confirm that the number is entered correctly.

To correct a mistake, press **CANCEL** and enter the correct number.

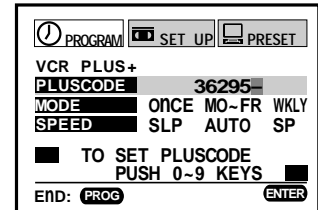

**3** Select “MODE” using **PLAY/x2** or **STOP**, and set the recording frequency.

**ONCE:** To record once.

**DAILY(MO~FR):** To record programs on the same channel at the same time Monday through Friday.

**WEEKLY:** To record programs on the same channel at the same time on the same day every week.

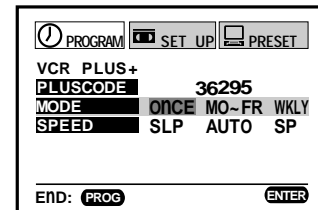

**4** Select “SPEED” using **PLAY/x2** or **STOP**, and set the recording tape speed.

For AUTO speed, see page 27.

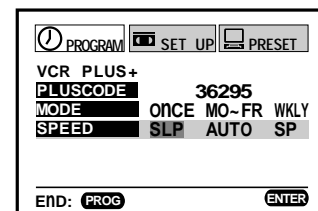

(Continued)

## VCR Plus+ C<sup>3</sup>® system Recording (continued)

- 5** Press **ENTER**.  
The program setting is now memorized.
- If your cable box is not remote-controllable, select the recording channel on the cable box beforehand.

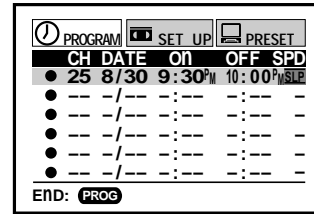

- 6** To set another program, repeat steps 1 to 5.

- 7** To finish press the two **TIMER** buttons simultaneously.  
The VCR enters the timer standby mode.

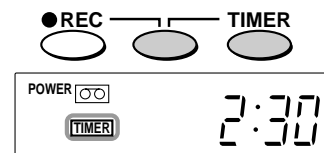

### Confirming the VCR Plus+ C<sup>3</sup>® system timer programs

#### Before the VCR enters the timer standby mode (TIMER indicator not lit)

- 1) Press **PROG.** to display the MENU screen.
- 2) Press **ENTER** to select "PROGRAM".  
Check the programmed data.
- 3) Press **PROG.** to exit.

#### During the timer standby mode (TIMER indicator lit)

Press **PROG..**

The screen for confirming appears.

After about 30 seconds, the screen disappears.

### Canceling the VCR Plus+ C<sup>3</sup>® system timer programs

- 1) If the **TIMER** indicator is lit, press both **TIMER** to turn it off, and turn on the VCR by pressing **POWER**.
- 2) Press **PROG.** to display the MENU screen.
- 3) Press **ENTER** to select "PROGRAM".
- 4) Select a program which you want to cancel.
- 5) Press **CANCEL**.  
The line is cleared out.
- 6) Press **PROG.** to exit.

### Recording or playback in the timer standby mode

First press both **TIMER** to release the timer standby mode, and then press **POWER** to turn on the VCR. The VCR will be available for use.

- Be sure to press both **TIMER** again to return the VCR to the timer standby mode after you have finished.

### Error indications

If "FULL / CANCEL PROG?" message appears on the TV during programming, no more programs can be entered. If you want to add another, delete one existing program on the screen by using **PLAY/x2** or **STOP**.

If an incorrect PlusCode® programming number is entered, "ERROR CODE ENTERED" appears on the screen. Press **CANCEL** to clear the number and enter correct one.

If "CLASH" message appears on the TV during programming, it tells you that two programs with the same recording start time have been entered. Correct either of the two programs as follows:

- 1) Select the number of the program to correct by using **PLAY/x2** or **STOP**.
- 2) Correct the data, or clear out the line by pressing **CANCEL** and then press **VCR Plus+** to enter a PlusCode® programming number.



# Cable Box Set-up

The VCR can directly control channel selecting of the connected cable box.

## Cable Box Control

This VCR needs to be connected to a cable box equipped with an infrared wireless remote control. You can select cable channels from the cable box by operating this VCR.

It is also possible to automatically change the cable channels according to your program setting in the timer program recording or VCR Plus+ C<sup>3</sup>® system recording.

## Placing the Cable Box

Put the cable box on the top of the VCR as shown below. Do not block the sensor window.

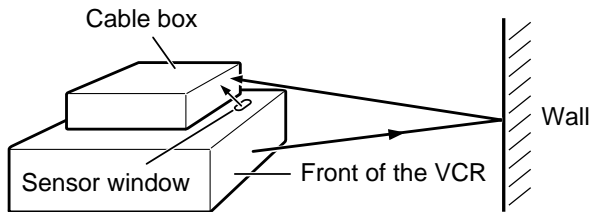

The infrared signals come out of the sensor window and the front of the VCR. Then they bounce off walls and other objects in the room and are received by the cable box. The VCR sends out infrared signals to your cable box even during timer program recording or VCR Plus+ C<sup>3</sup>® system recording.

### Notes

- If the channels cannot be controlled properly because the infrared signal fails to reach the cable box, change the position of the box on the VCR so that it can receive the signal.
- Keep the cable box turned on even while the VCR is in the timer program recording or VCR Plus+ C<sup>3</sup>® system recording.

## Connection Type

### Type A

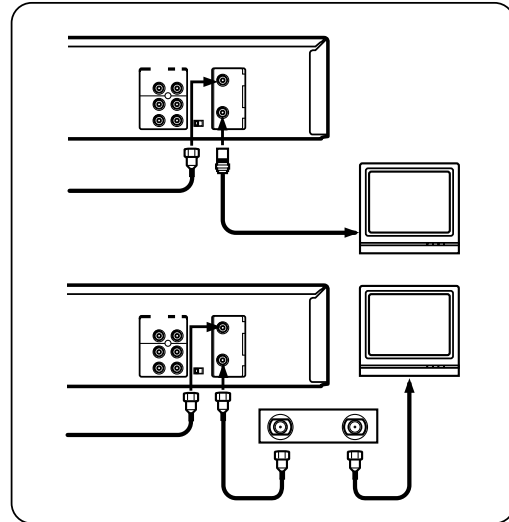

### Type B

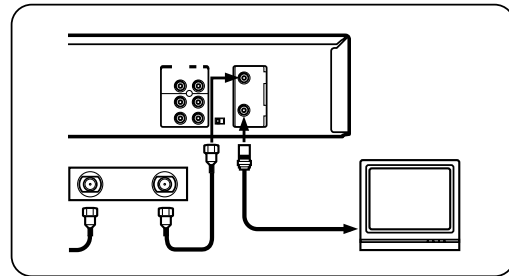

### Type C

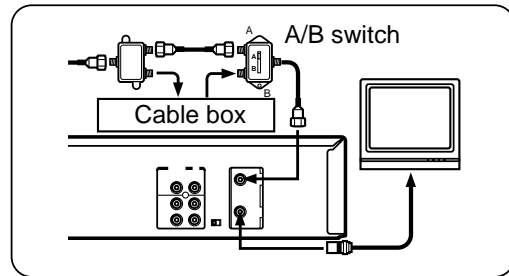

### Type D

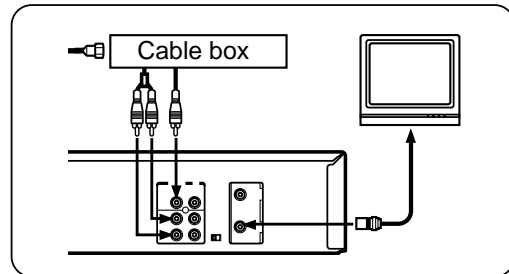

## Cable Box Set-up (continued)

### Preparation

- Select the video channel (3 or 4) or video input mode on the TV.
- Set "TV/CATV" on the CH MEMORY screen to "CATV" (page 17).

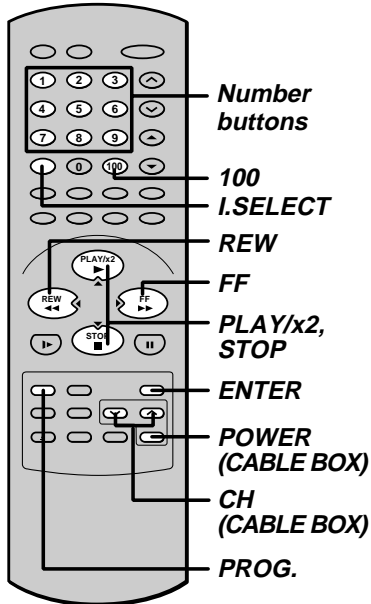

## Cable Box Set-up

- 1 Press **PROG.** to display the MENU screen.
- 2 Select "PRESET" using **FF** or **REW**, and press **ENTER**.
- 3 Select "CABLE BOX/DSS" using **PLAY/x2** or **STOP**, and press **ENTER**.
- 4 Select "NO" or "C.BOX" using **FF** or **REW** according to your connection type.
  - NO:**
    - Type A
    - Type C (A/B switch "A")
  - Cable channels will be selected using **CH/TRK** on the remote control or **CHANNEL** on the VCR.
  - Go to step 8.
  - C.BOX:**
    - Type B
    - Type C (A/B switch "B")
    - Type D
  - Go to step 5.
- 5 Select "OUTPUT CH" using **PLAY/x2** or **STOP**, and enter either of the following according to your connection. (Example)
  - Type B, C:** the output channel number of your cable box using **number buttons**. (Usually 3 or 4. Check the rear of the cable box.)
  - Type D:** the line input mode "L1" using **I.SELECT**.
- 6 Select "CONTROL" using **PLAY/x2** or **STOP**, and set to "ON" or "OFF" using **FF** or **REW**.
  - ON:** if your cable box is remote-controllable.
    - Cable channels will be selected by **CH (CABLE BOX)** on the remote control. The VCR can change the cable channel to the desired one when timer recording or VCR Plus+ C<sup>3</sup>® system recording starts.
    - Go to step 7.
  - OFF:** if your cable box is NON remote-controllable.
    - Cable channels will be selected by the own channel selector of the cable box. The VCR channel should be set to the output channel of the cable box.
    - Go to step 8.

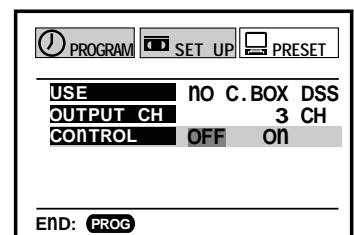
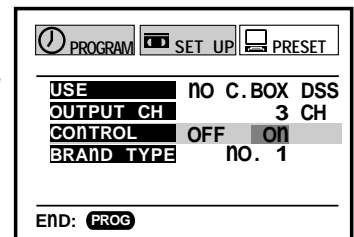
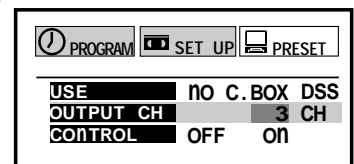
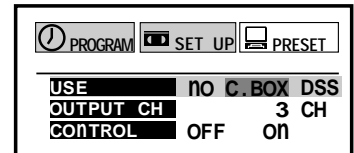
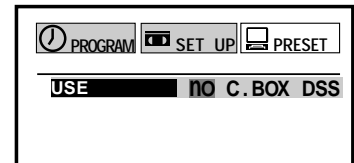

- 7** Select “BRAND TYPE” using **STOP**, and enter a brand code of your cable box using **number buttons**. Refer to the table on the next page.

**Example:** For a TOSHIBA cable box, identified by number 36.

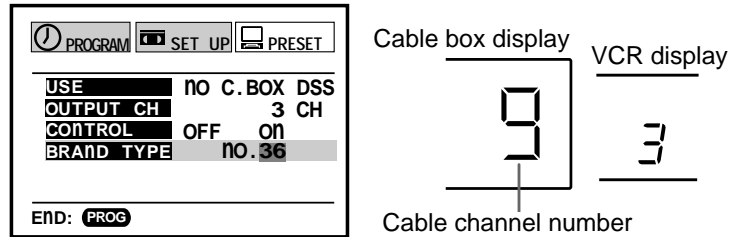

Make sure that the channel display of your cable box has changed to 9. If not, try each brand code assigned to the brand of your cable box until the display changes to 9.

If it still holds;

- Relocate the cable box on the VCR.
- Use each of digits from 1 to 91.

- 8** Press **PROG.** to exit.

#### Notes

- If your cable channel does not change to 9 in step 7, the cable box will not be able to change channels in the timer recording. In this case, set “CONTROL” to “OFF” in step 6.
- The cable box control is not compatible with the DSS® satellite receiver control.

### Buttons to control a remote-controllable cable box

Once you complete the set-up for a remote controllable cable box, your cable box can be controlled by the following buttons on the remote control of the VCR.

- **POWER (CABLE BOX)**  
To turn the cable box on or off.
- **CH (CABLE BOX)**  
To select cable channels in the upper or lower direction. (not applicable to some brands of cable box.)
- **Number buttons (0 – 9)**  
To select desired channels to record.
- **100**  
Some cable boxes require you to use this button as the enter button. Press this button after selecting the cable channel with number buttons.

## Cable Box Set-up (continued)

Table of cable box brand codes

Brand name of your cable box	Brand code
Toshiba	36
Anvision	13, 20, 21, 22, 23, 24, 25, 26, 58, 62, 84
Archer	1, 20, 21, 29, 42, 44, 63, 88, 91
Cablestar	13, 20, 21, 22, 23, 24, 25, 26, 58, 62, 84
Cableview	30, 42, 44, 52, 63, 88
Citizen	30, 42, 44, 52, 63, 88
Curtis	8, 9, 56, 61
Diamond	1, 20, 21, 29, 42, 44, 63, 88, 91
Eagle	13, 20, 21, 22, 23, 24, 25, 26, 58, 62, 84
Eastern	26, 28
GC Brand	30, 42, 44, 52, 63, 88
Gemini	4, 30, 85
General Instrument	1, 2, 3, 4, 31, 34, 55, 85, 91
Hamlin	14, 15, 28, 41
Hitachi	31, 79, 80
Jerrold	1, 2, 3, 4, 31, 34, 55, 85, 91
Macom	31, 79, 80
Magnavox	13, 20, 21, 22, 23, 24, 25, 26, 58, 62, 84
Movietime	29, 32, 38, 39, 42, 44, 88
NSC	29, 32, 38, 39, 42, 44, 88
OAK	10, 11, 12, 13, 46
OAK Sigma	10, 11, 12, 13, 46
Panasonic	6, 8, 16, 17
Philips	4, 13, 20, 21, 22, 23, 24, 25, 26, 58, 62, 84
Pioneer	5, 6, 78
Pulsar	30, 42, 44, 52, 63, 88
Randtek	13, 20, 21, 22, 23, 24, 25, 26, 58, 62, 84
RCA	6, 8, 16, 17
Realistic	44, 88
Regal	14, 23, 41, 84
Regency	26, 28
Rembrandt	29, 32, 38, 39, 42, 44, 88
Samsung	4, 6, 32, 42, 78
Scientific Atlanta	8, 9, 56, 61
Sheritech	27
SL Mark	4, 6, 32, 42, 78
Sprucher	6, 8, 16, 17
Stargate	4, 6, 30, 32, 42, 44, 52, 63, 78, 88
Sylvania	19
Teknika	74

Brand name of your cable box	Brand code
Telecaption	77
Televue	4, 6, 32, 42, 78
Texscan	18, 19
Tocom	1, 33, 34, 42, 48, 49, 73, 91
Unika	1, 20, 21, 29, 42, 44, 63, 88, 91
Universal	29, 42, 43, 44, 52, 63, 82, 88
Videoway	7, 23, 45, 50, 84
Viewstar	13, 20, 21, 22, 23, 24, 25, 26, 58, 62, 84
Warner Amex	6
Zenith	7, 23, 45, 50, 84

# DSS® Satellite Receiver Set-up

The VCR can directly control channel selecting of the connected DSS® satellite receiver.

## DSS® Satellite Receiver Control

This VCR needs to be connected to a DSS® satellite receiver equipped with an infrared wireless remote control. You can select satellite channels from the DSS® satellite receiver by operating this VCR.

DSS® is registered trademark of DIRECTV, Inc., a unit of GM Hughes Electronics. It is also possible to automatically change the satellite channels according to your program setting in the timer program recording.

## Placing the DSS® Satellite Receiver

Put the DSS® satellite receiver on the top of the VCR as shown below. Do not block the sensor window.

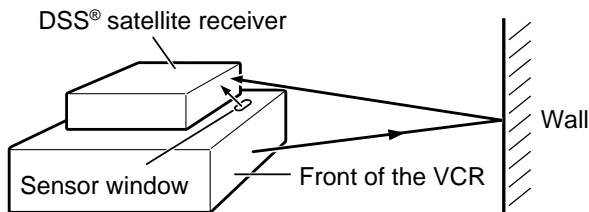

The infrared signals come out of the sensor window and the front of the VCR. Then they bounce off walls and other objects in the room and are received by the DSS® satellite receiver. The VCR sends out infrared signals to your DSS® satellite receiver even during timer program recording.

### Notes

- If the channels cannot be controlled properly because the infrared signal fails to reach the DSS® satellite receiver, change the position of the receiver on the VCR so that it can receive the signal.
- Keep the DSS® satellite receiver turned on even while the VCR is in the timer program recording.

## Connection Type

### Type A

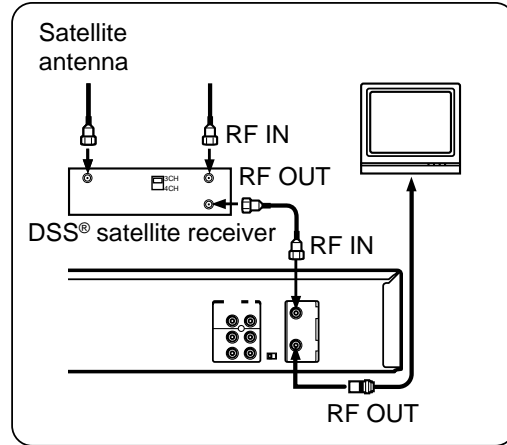

### Type B

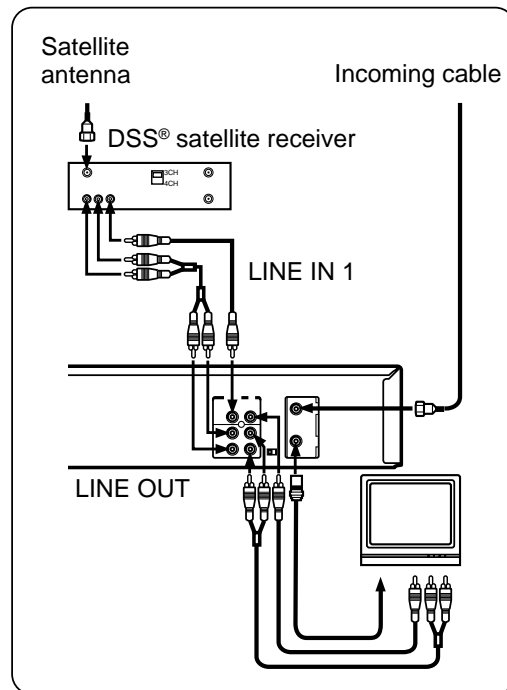

RECORDING

# DSS® Satellite Receiver Set-up (continued)

## Preparation

Select the video channel (3 or 4) or video input mode on the TV.

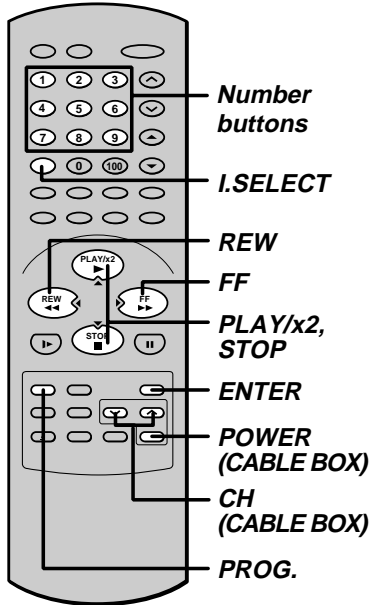

## DSS® Satellite Receiver Set-up

**1** Press **PROG.** to display the MENU screen.

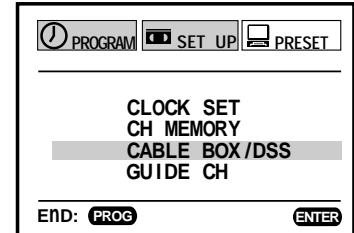

**2** Select "PRESET" using **FF** or **REW**, and press **ENTER**.

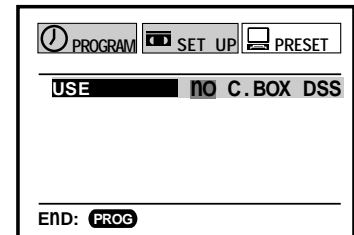

**3** Select "CABLE BOX/DSS" using **PLAY/x2** or **STOP**, and press **ENTER**.

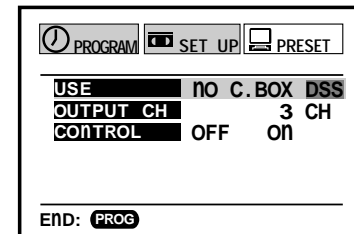

**4** Select "DSS" using **FF**.

**5** Select "OUTPUT CH" using **PLAY/x2** or **STOP**, and enter either of the following according to your connection. (Example)

**Type A:** the output channel number of your DSS® satellite receiver using **number buttons**. (Usually 3 or 4. Check the rear of the DSS® satellite receiver.)

**Type B:** the line input mode "L1" using **I.SELECT**.

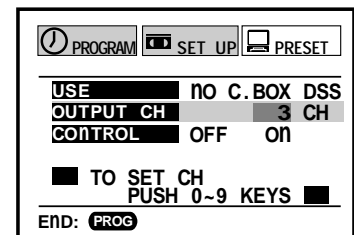

- 6** Select "CONTROL" using **PLAY/x2** or **STOP**, and set to "ON" or "OFF" using **FF** or **REW**.

**ON:** if your DSS® satellite receiver is remote-controllable.

- Satellite channels will be selected by **CH (CABLE BOX)** on the remote control.  
The VCR can change the satellite channel to the desired one when timer recording starts.

→ Go to step 7.

**OFF:** if your DSS® satellite receiver is NON remote-controllable.

- Satellite channels will be selected by the own channel selector of the DSS® satellite receiver.  
The VCR channel should be set to the output channel of the DSS® satellite receiver.

→ Go to step 8.

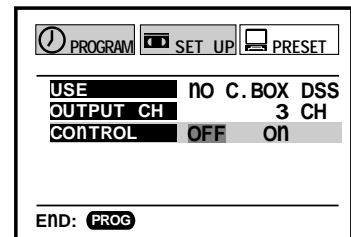
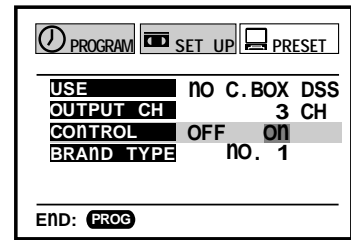

- 7** Select "BRAND TYPE" using **STOP**, and enter a brand code of your DSS® satellite receiver using **number buttons**. Refer to the table on the next page.

**Example:** For a TOSHIBA DSS® satellite receiver, identified by number 99.

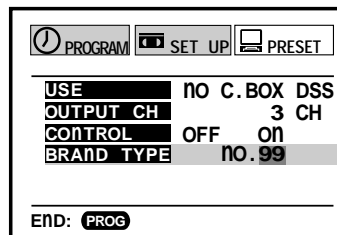

VCR display

3

Make sure that the background of the above display has changed to the satellite program on channel 200. If not, relocate the DSS® satellite receiver on the VCR so that it can receive the infrared signal.

- 8** Press **PROG.** to exit.

#### Notes

- If your satellite channel does not change to 200 in step 7, the DSS® satellite receiver will not be able to change channels in the timer recording. In this case, set "CONTROL" to "OFF" in step 6.
- The VCR Plus+ C<sup>3</sup>® system recording is not available on satellite channels.
- The DSS® satellite receiver control is not compatible with the cable box control.

## *DSS® Satellite Receiver Set-up (continued)*

### Buttons to control a remote-controllable DSS® satellite receiver

---

Once you complete the set-up for a remote controllable DSS® satellite receiver, your DSS® satellite receiver can be controlled by the following buttons on the remote control of the VCR.

- **POWER (CABLE BOX)**  
To turn the DSS® satellite receiver on or off.
- **CH (CABLE BOX)**  
To select satellite channels in the upper or lower direction. (not applicable to some brands of DSS® satellite receiver.)
- **Number buttons (0 – 9)**  
To select desired channels to record.

### Table of DSS® satellite receiver brand codes

---

Brand name of your DSS® satellite receiver	Brand code
TOSHIBA	99
RCA	98
SONY	97



# MTS Broadcast Compatibility

This VCR can receive or record MTS (Multichannel TV Sound) broadcasts. By connecting the VCR to your stereo system or stereo TV, you will experience the SAP or stereo sound.

## Preparation

Connect a stereo TV or stereo system to the AUDIO OUT jacks of the VCR.

## Recording the SAP/Stereo Broadcast

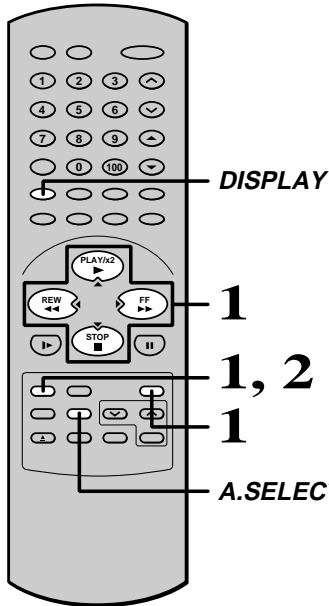

- 1 On the SET UP screen (page 15), select "SAP SET" using **PLAY/x2** or **STOP**, and set to "ON" using **REW** or **FF**.

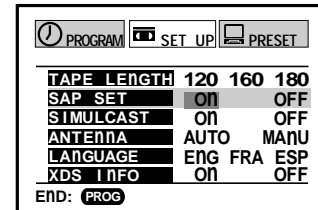

- 2 Press **PROG.** to exit.
- 3 Perform a recording.

### SAP (Second Audio Program broadcast):

A separate audio program, usually broadcast in a second language with the main language.

RECORDING

## Selecting a sound

### Sounds recorded on the tape

According to your setting of "SAP SET" on the SET UP screen, the sound is recorded onto different tracks of the tape as below. Set "SAP SET" to "ON" or "OFF" appropriately.

Type of receiving broadcast	Setting of "SAP SET" on the SET UP screen	On-Screen Display (Press <b>DISPLAY</b> .)		Contents of recorded sound		
		"SAP"	"STEREO"	Normal sound track (Mono)	Hi-Fi sound track	
					L	R
Regular (monaural audio)	"ON" or "OFF"	not lit	not lit	MONO	MONO	MONO
Stereo	"ON" or "OFF"	not lit	lit	MONO (MIXED)	STEREO	
Regular+SAP	"ON"	lit	not lit	MONO	MONO	SAP
	"OFF"	lit	not lit	MONO	MONO	MONO
Stereo+SAP	"ON"	lit	lit	MONO	MONO	SAP
	"OFF"	lit	lit	MONO (MIXED)	STEREO	

### Sounds in playback

You can play SAP and/or stereo broadcasts with this VCR. Press **A.SELECT** to select a desired sound.

Desired sound	L , R indicators in the VCR display	Sound output
SAP sound	R (right) is on.	SAP
Stereo sound	Both R (right) and L (left) are on.	Stereo

### Note

When the TV is connected to the RF OUT terminal of the VCR, the output sound is monaural.

# Simulcast Recording

When TV program such as MTV, HBO or MAX is being simulcast in FM stereo in your area, the VCR can also record the simulcast sound from an FM stereo tuner or receiver onto the Hi-Fi track and normal track.

## Preparation

- Connect the TV and stereo system to the VCR as below.
- Turn on the connected FM tuner and tune to the station for the simulcast program.

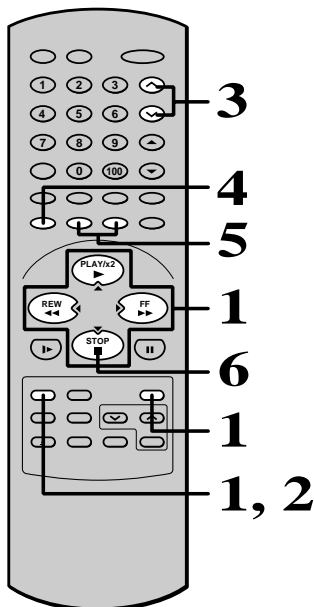
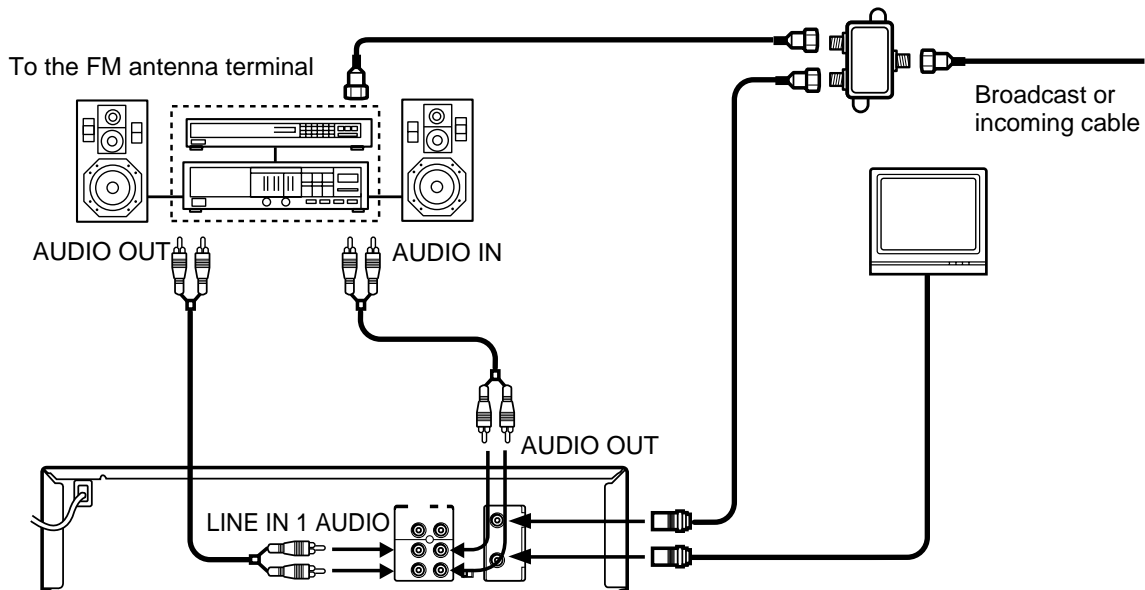

## Simulcast Recording

- 1 On the SET UP screen (page 15), select "SIMULCAST" using **PLAY/x2** or **STOP**, and set to "ON" using **REW** or **FF**.

PROGRAM	SET UP	PRESET
TAPE LENGTH	120 160 180	
SAP SET	ON OFF	
SIMULCAST	ON OFF	
ANTENNA	AUTO MANU	
LANGUAGE	ENG FRA ESP	
XDS INFO	ON OFF	
END:	PROG	

- 2 Press **PROG.** to exit.
- 3 Select the desired channel using **CHANNEL** on the VCR or **CH/TRK** on the remote control.  
If you use a cable box, select a desired channel on the box.
- 4 Select the recording tape speed using **SP/SLP**.
- 5 Press **REC** to start recording.
- 6 Press **STOP** to stop recording.

# Multi Brand Remote Control

The remote control can be compatible with various brands of TV by setting their control codes. The TOSHIBA code has initially been set to control TOSHIBA TVs.

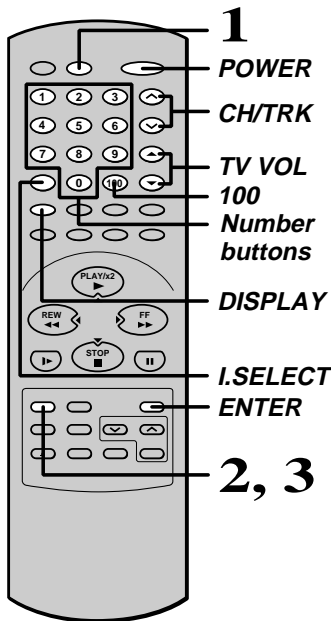

## Setting Control Codes

- 1** Press **TV** to set the remote control operating your TV.
- 2** While holding down **PROG.**, enter the two digits of your TV's brand code (listed on page 44) using **number buttons**.
 

Hold down.

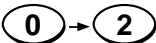

Example

- 3** Release **PROG.**.
- 4** Point the remote control at your TV and use each button listed below to make sure that your TV is operated correctly.

<i>POWER</i>	To turn the TV on or off.
<i>CH/TRK</i>	To select TV channels in the upper or lower direction.
<i>TV VOL</i>	To adjust the sound level.
<i>I.SELECT</i>	To select an external source such as a VCR.
<i>Number buttons</i>	To select TV channels. When selecting channels 1 to 9, first enter 0 and then the desired number.
<i>100</i>	To substitute for 100 channel key.
<i>DISPLAY</i>	To turn on or off TV's screen display.
<i>ENTER</i>	To use for the TV's ENTER key.

### Important

Some TVs may not respond to all the operations above, or may not be operated at all with this remote control. In this case, operate your TV with its own remote control.

### Notes

- For some brands, several control codes (brand codes) are allocated. Try each of them until the buttons work on your TV.
- If you replace the remote control's batteries, set the brand code again.

## *Multi Brand Remote Control (continued)*

Table of Brand Codes

Brand name of your TV	Brand Code
Toshiba	01
Bell & Howell	09
Carver	10
Celebrity	03
Citizen	12
Curtis Mathes	09, 12
Dumont	14
Electro band	03
Emerson	09, 11
Fisher	09
GE	02, 07, 11
Gibraltar	14
Goldstar	11
Hallmark	11
Hitachi	06
Infinity	10
JBL	10
JCB	03
JVC	05
LXI	01, 02, 09, 10, 11
Magnavox	10
Marantz	10
Megatron	06, 11
Memorex	04, 09, 11
MGA	04, 11
Midland	02, 07, 14
Mitsubishi	04, 11
Motorola	08
MTC	12
NAD	01, 11
Nikko	11
Optimus	09
Optonica	08
Panasonic	07, 10, 15
Penney	01, 02, 07, 11, 12
Philco	10
Philips	10
Pioneer	16
Princeclub	12
Prism	07
Proscan	02

Brand name of your TV	Brand Code
Proton	11
Pulser	14
Quasar	07, 15
Radio Shack	13
RCA	02
Realistic	09, 11, 13
Runco (NEC)	14
Samsung	11, 12
Sanyo	09
Scotch	11
Scott	11
Sears	01, 02, 09, 10, 11
Sharp	08, 13
Sony	03
Soundesign	11
Supreme	03
Sylvania	10
Tandy	08
Technics	07, 15
Techwood	07
Teknika	04, 10, 12
TMK	11
Victor	05
Vidikron	10
Vidtech	11
Wards	10, 11, 13
Zenith	14

# Before Calling Service Personnel

Check the following symptoms before requesting servicing.

## No power.

- The power cord is not plugged in.
- **Plug the power cord into the outlet firmly.**

## Although the power is on, the VCR will not work.

- There is no cassette.
- **Load a cassette. (page 19)**

## The clock does not work.

- There has been a power failure.
- **Reset the clock. (page 16)**

## The timer does not work properly.

- The time is incorrect.
- **Set the clock correctly. (page 16)**

## The picture does not appear on the TV screen.

- The video channel or video input mode is not set correctly.
- **Set the TV channel to the video channel (3 or 4) or set the video input mode on the TV. (page 11)**
- The TV signal is weak.
- **Adjust the antenna direction or use an optional antenna booster.**
- The power cord is not plugged in.
- **Plug the power cord into the outlet firmly.**

## The picture does not appear on the TV screen during recording and playback.

- The video channel or VCR mode is not set correctly.
- **Press TV/VCR to select the VCR mode and set the TV channel to 3 or 4. (pages 11, 25)**

## The VCR does not record.

- The loaded cassette has no safety tab.
- **Use a cassette with a safety tab or cover the hole with adhesive tape. (page 19)**

## The playback picture is poor.

- Tracking is not set appropriately.
- **Adjust the tracking manually. (page 20)**
- The video heads are dirty.
- **Clean the video heads with a commercially available cleaning tape.**

## The desired sound is not heard, such as SAP, stereo, or regular sound.

- Setting of sounds is not correct.
- **Select a desired sound using A.SELECT. (page 41)**

## Noise is present in the Hi-Fi sound being played.

- Tracking is not set appropriately.
- **Adjust the tracking manually. (page 20)**

## The timer recording function does not work.

- There is an error in programming.
- **Reset the timer recording program. (page 26)**
- There is no cassette in the VCR.
- **Load a cassette with the safety tab attached. (page 19)**
- The cassette does not have the safety tab.
- **Use another cassette with a safety tab or cover the hole with adhesive tape. (page 19)**
- The timer indicator is not displayed.
- **Press both TIMER simultaneously. (page 27)**
- There has been a power failure.
- **Reset the clock. (page 16)**
- The cable box set-up has not been set correctly.
- **Make the set-up correctly. (page 34)**
- The cable box is not turned on.
- **Turn on the cable box.**

## The VCR Plus+ C<sup>3</sup>® system recording cannot be done.

- The guide channel numbers are not set up correctly.
- **Make the guide channel number setting. (page 29)**
- The cable box is not turned on when the channel comes in the VCR via the cable box.
- **Turn on the cable box.**
- The cable box set-up has not been set correctly.
- **Make the set-up correctly. (page 34)**
- The timer indicator is not displayed.
- **Press both TIMER simultaneously. (page 32)**

## *Before Calling Service Personnel (continued)*

The remote control does not work properly.

---

- The batteries are exhausted.
  - **Replace all batteries. (page 10)**
- The remote control is operated beyond the operating range.
  - **Make sure the remote control is within 30° of the remote sensor on the VCR. (page 10)**
- Too far from the VCR.
  - **Use the remote control within 7 m from the front of the VCR. (page 10)**
- An obstacle may be in the way of the operation.
  - **Remove the obstacle.**
- The operating mode of the remote control is not set correctly.
  - **Press VCR or TV depending on the equipment you want to operate. (pages 14, 43)**

The cassette is ejected immediately after it is loaded.

---

- The cassette was inserted with the label side not paralleling the compartment.
  - **Reload it carefully. (page 19)**

The cassette does not go into the cassette compartment.

---

- There is already a cassette in the VCR.
  - **Eject the cassette and reload the new one. (page 19)**

# Specifications

<b>Power supply:</b>	120 V AC, 60 Hz
<b>Power consumption:</b>	19 W
<b>External dimensions:</b>	430 × 96.5 × 281 mm (W.H.D.)
<b>Mass:</b>	3.8 kg
<b>Channels received:</b>	VHF: Channels 2–13 UHF: Channels 14–69 CATV: Channels 1–125
<b>Antenna input/output terminals:</b>	UHF/VHF: 75 Ω F type connector
<b>Signal system:</b>	Standard NTSC
<b>Recording/Playback system:</b>	Recording: VHS format (SP, SLP) Playback: VHS format (SP, LP, SLP)
<b>Cassette:</b>	Video cassette with <b>VHS</b> mark
<b>Tape speed:</b>	SLP: 11.1 mm/s, SP: 33.4 mm/s
<b>Video recording/playback time:</b>	SLP: 480 minutes, SP: 160 minutes (When T-160 video cassette is used.)
<b>Fast forward time:</b>	Within approx. 80 s (When T-120 video cassette is used.)
<b>High speed rewind time:</b>	Within approx. 54 s (when T-120 video cassette is used.)
<b>Video input:</b>	1 V (p-p), 75 Ω, unbalanced, negative sync., pin jack
<b>Video output:</b>	1 V (p-p), 75 Ω, unbalanced, negative sync., pin jack
<b>Audio input:</b>	Line input: 308 mV (rms), more than 47 kΩ, pin jack
<b>Audio output:</b>	Line output: 308 mV (rms), less than 4.7 kΩ, pin jack
<b>Audio frequency range (Hi-Fi):</b>	20 Hz – 20 kHz
<b>Audio dynamic range (Hi-Fi):</b>	90 dB
<b>Utilization conditions:</b>	Temperature: 5°C to 40°C Humidity: less than RH 80%

# Accessories

Antenna cable .....	1
Remote control .....	1
Batteries (AAA) .....	2

Designs and specifications are subject to change without notice.

# LIMITED WARRANTY TOSHIBA VIDEO CASSETTE RECORDER

---

Toshiba America Consumer Products, Inc. ("TACP") and Toshiba Hawaii Inc. ("THI") make the following limited warranties. These limited warranties extend to the original consumer purchaser or any person receiving this set as a gift from the original consumer purchaser and to no other purchaser or transferee.

## **Limited Ninety (90) Day Warranty**

TACP/THI warrant this product against defects in materials or workmanship for a period of ninety days after the date of original retail purchase. During this period, TACP/THI will repair a defective product or part, without charge to you. You must deliver the entire product to a TACP/THI Authorized Service Station. You are responsible for all transportation and insurance charges for the set to and from the Authorized Service Station.

## **Limited One (1) Year Warranty**

TACP/THI further warrant the parts in this product against defects in materials or workmanship for a period of one (1) year after the date of original retail purchase. During this period, TACP/THI will replace a defective part without charge to you, except that if a defective part is replaced after ninety (90) days from the date of the original retail purchase, you pay labor charges involved in the replacement. You must also deliver the entire product to a TACP/THI Authorized Service Station. You are responsible for all transportation and insurance charges for the set to and from the Authorized Service Station.

## **Rental Units**

The warranty for rental units begin with the first rental or thirty (30) days from the date of shipment to the rental firm, whichever comes first.

## **Commercial Units**

Products sold and used for commercial use have a limited ninety (90) day warranty for all parts and labor.

## **Owner's Manual and Demographic Card**

You should read the owner's manual thoroughly before operating this product. You should complete and mail the enclosed Demographic card within ten (10) days after you, or the person who has given you this product as a gift, purchased this product. This is one way to enable TACP/THI to provide you with better customer service and improved products. Failure to return the card will not affect your rights under this warranty.

## **Your Responsibility**

The above warranties are subject to the following conditions:

- (1) You must retain your bill of sale or provide other proof of purchase.
- (2) You must notify an Authorized TACP/THI Service Station within thirty (30) days after you discover a defective product or part.
- (3) All warranty servicing of this product must be made by an Authorized TACP/THI Service Station.
- (4) These warranties are effective only if the product is purchased and operated in the U.S.A or Puerto Rico.
- (5) Labor service charges for set installation. Set up, adjustment of customer controls and installation of repair or antenna systems are not covered by this warranty. Reception problems caused by inadequate antenna systems are your responsibility.
- (6) Warranties extend only to defects in materials or workmanship as limited above and do not extend to any product or parts which have been lost or discarded by you or to damage to products or parts caused by misuse, accident, damage caused by Acts of God, such as lightning or fluctuations in electric power, improper installation, improper maintenance or use in violation of instructions furnished by us; or to units which have been altered or modified without authorization of TACP/THI or to damage to products or parts there of which have had the serial number removed, altered, defaced or rendered illegible.
- (7) At your option, after the warranty period has expired in the U.S.A. Call (800)-631-3811 to receive information concerning an exchange price. Payment must be enclosed with the product in the form of a certified check or money order and forward your product to:  
Toshiba America Consumer Products Inc.  
Returns Center  
1420C Toshiba Dr.  
Lebanon, TN 37087
- (8) Upon receipt we will, at our option, replace your unit with a new or refurbished unit of equal value. Features may not be identical to your original product.
- (9) Physically damaged units are not acceptable for repair or exchange in or out of warranty and will be returned as received.



## LIMITED WARRANTY (continued)

### How to Obtain Warranty Service

- (1) Refer to the troubleshooting guide in your owner's manual. This check list may solve your problem.
- (2) Call the TACP toll free number **800-631-3811** within (30) days after you find a defective product or part.
- (3) Arrange for the delivery of the product to the Authorized TACP/THI Service Station. Products shipped to the Service Station must be insured and safely and securely packed, preferably in the original shipping carton, and a letter explaining the defect and also a copy of the bill of sale or other proof of purchase must be enclosed.

**In the Continental United States contact:**



**In Hawaii contact**

Toshiba Hawaii  
327 Kamakee Street,  
Honolulu, HA 96814  
(808)-591-8377

All warranties implied by state law, including the implied warranties of merchantability and fitness for a particular purpose, are expressly limited to the duration of the limited warranties set forth above. With the exception of any warranties implied by state law as hereby limited, the foregoing warranty is exclusive and in lieu of all other warranties, guarantees, agreements and similar obligations of manufacturer or seller with respect to the repair or replacement of any parts. In no event shall TACP/THI be liable for consequential or incidental damages.

No person, agent, distributor, dealer or company is authorized to change, modify or extend the terms of these warranties in any manner whatsoever. The time within action must be commenced to enforce any obligation of TACP/THI arising under the warranty or under any statute, or law of the United States or any state thereof, is hereby limited to ninety (90) days from the date you discover or should have discovered the defect. This limitation does not apply to implied warranties arising under state law. This warranty gives you specific legal rights and you may also have other rights which may vary from state to state. Some states do not allow limitation on how long an implied warranty lasts, when an action may be brought or the exclusion or limitation of incidental or consequential damages, so the above provisions may not apply to you.

#### **ATTENTION CANADIAN CONSUMERS:**

Canadian consumers are requested to complete the special Canadian "Warranty Registration Form" enclosed and forward this completed form with a copy of bill of sale to TOSHIBA OF CANADA to "Register and Validate" their warranty. Product must be purchased from an Authorized Canadian Dealer.

Products purchased in the U.S.A and used in Canada are not covered by these warranties.

#### **IMPORTANT: PACKING AND SHIPPING INSTRUCTION**

When you send the product to a Service Station, you should use the original carton box and packing material, then insert the original carton box containing the unite into another carton, using more packing material.

**TOSHIBA AMERICA CONSUMER PRODUCTS, INC.**